



SMART SEATING

# price list 2015

**SUGGESTED LIST PRICING**

JUNE 2015 • 1<sup>ST</sup> EDITION, REVISION 2

---

**Welcome to the 2015 generation of OM's price book.**

OM works very hard to produce high-quality, ergonomic seating that fits perfectly into any working environment, and any working budget.

As a company, we strive to maintain our focus on the well-being and complete satisfaction of all our customers—big, small, institutional, healthcare, corporate or others.

To help accomplish this, we do our best to develop useful tools that help everyone who works with our products; whether it's sales representatives, specifiers, facilities and/or customer service personnel:

Our Website ([omsmartseating.com](http://omsmartseating.com)) is loaded with many frequently updated tools to keep you fully informed about our company news, events, new and existing product details, adjustments, videos, fabric selections, and much, much more.

Our Customer Service personnel (**toll-free 877 776 5678**) are always on-hand, Monday through Friday 7:30 AM PST to 5:30 PM PST to help field any questions, concerns, or perhaps even great OM success stories that you'd care to share!

Our Manufacturer's Sales Representatives (full contact list available via link at top right corner of our website) are friendly, knowledgeable, and dedicated to working for you by providing valuable project assistance, demo and product-selection support, and myriad other indispensable services.

This OM Price Book (June 2015 • 1<sup>st</sup> Edition, Revision 1) is newly redesigned in several useful ways that will really facilitate your furniture selection activities; at least where it comes to your OM seating selection anyway!

If you haven't already, we invite you to get to know us and once you do, we think you'll agree that our unique brand of personal care and attention to detail is truly an intangible factor that sets OM apart from other seating manufacturers.

Some of the new features that you'll find inside our redesigned June 2015 • 1<sup>st</sup> Edition, Revision 1 Price Book:

1. Re-organization of our entire price book. We've made it easier to find the OM chairs you love for whatever environment you're working in by returning to a primarily alphabetical listing of all our seating. However, we did create 2 groupings for our extensive seating selection by having 2 sections: The first is one for task, executive, conference and general "work chairs", and then a second section is dedicated to stackable, guest, and specialty seating.
2. Useful Intra-Family Groupings. Within each Family/Model Series section, we've grouped chairs with like characteristics – similar proportions or features – together and labeled them with a "guidance flag" to help you know the logic. We've also added a suggestions/commonly ordered options guide near the end of each family section; this section shows the same features you'd find at the back of the book, but just located closer for convenience and ease-of-reference.
3. Multiple Table of Content Arrangements. If you need any help finding a product (whether you're a longtime supporter looking for a specific model, or an "OM newbie" searching for a certain type of seating), simply flip to the front of the book to find models by: Application, Type of use, Control functionality, or Model name. If you have further questions, please call us!
4. Expanded Grade-in's List. Now located near the back of this book, find everything related to C.O.M.'s, Grade-in's, or general upholstery questions in one complete section.
5. Updated Manufacturer's Warranty. Please browse to page 124 of this book to find the newly updated Limited Manufacturer's Warranty that will go into effect for orders placed from May 31 2015, and that supersedes older warranties printed on pre-May 2015 literature.

If you have any questions about navigating this book, or what OM seating fits your environment the best, we invite you to contact us: 877 776 5678 or [om@officemaster.com](mailto:om@officemaster.com)

**OM TAB STICKERS: go to the last page of this book for stickers to tab your favorite price list sections.**

|                                     |   |
|-------------------------------------|---|
| Table of contents by application    | 3 |
| Table of contents by category       | 4 |
| Table of contents by function & A-Z | 5 |
| What's new                          | 6 |
| Buyer's Guide                       | 7 |

**BY APPLICATION (environment)**

**conference/boardroom & executive**

|                                  |                  |         |
|----------------------------------|------------------|---------|
| AFFIRM SERIES (AF)               | AF504 – AF589    | 9 – 17  |
| OM5                              | OM5-B, OM5-G     | 53, 55  |
| OM5EX                            | OM5-BEX, OM5-GEX | 56, 57  |
| OM5XT                            | OM5-BXT, OM5-GXT | 58, 59  |
| CONFERENCE EXECUTIVE SERIES (CE) | CE88 – CE89      | 27, 28  |
| PACIFIC SERIES (9XXX)            | 9100 – 9200      | 61 – 63 |
| YES SERIES (YS)                  | YS70N – YS89     | 83 – 87 |

**general office**

|                             |             |         |
|-----------------------------|-------------|---------|
| PATRIOT VALUE SERIES (PA)   | PA53 – PA69 | 75 – 79 |
| PC SERIES (PC)              | PC53 – PC59 | 80, 81  |
| PARAMOUNT VALUE SERIES (PT) | PT62 – PTYM | 65 – 71 |
| PARAMOUNT SERIES (7XXX)     | 7770 – 7897 | 72, 73  |
| ZESTA SERIES (ZA)           | ZA62 – ZA98 | 89 – 91 |

**healthcare & lab**

|                                  |                 |         |
|----------------------------------|-----------------|---------|
| CLASSIC PROFESSIONAL SERIES (CL) | CL12 – CL35     | 29 – 31 |
| CLASSIC LAB & HEALTHCARE (CL)    | CL44EZ – CL48EZ | 32, 33  |
| CLASSIC LAB STOOLS (CLS)         | CLS53 – CLS61   | 35, 36  |
| DISCOVERY BACK SERIES (DB)       | DB52 – DB78     | 37 – 41 |

**heavy-duty**

|                                     |                               |        |
|-------------------------------------|-------------------------------|--------|
| 24-SEVEN 'HEAVY DUTY' SERIES (IUHD) | IU76HD – IU79HD               | 46, 47 |
| MAXWELL 24-SEVEN SERIES (MXIU/PD)   | MX84IU/PD – MX88IU/PD, 7878MX | 50, 51 |

**multi-shift & intense-use environments**

|  |                              |        |
|--|------------------------------|--------|
| INTENSIVE USE 24-SEVEN SERIES (IU)     | IU54 – IU76                  | 44, 45 |
| 24-SEVEN 'HEAVY DUTY' PD SERIES (IUPD) | IU76PD – IU79PD              | 46, 47 |
| MAXWELL 24-SEVEN SERIES (MXIU/PD)      | MX84IU/PD – MX88IUPD, 7878MX | 50, 51 |

**occasional use & waiting rooms**

|                             |                                |           |
|-----------------------------|--------------------------------|-----------|
| OM5 ACTIVE                  | OM5-AT, OM5-AS, OM5-AG, OM5-AC | 95 – 103  |
| STACKABLE GUEST SERIES (SG) | SG1K – SG5K                    | 107 – 110 |
| STACKING CHAIRS (ST)        | ST200 – ST400F                 | 111 – 113 |

**schools & education**

|           |             |         |
|-----------|-------------|---------|
| BC SERIES | BC41 – BC99 | 19 – 25 |
|-----------|-------------|---------|

**"special" applications**

|                          |             |           |
|--------------------------|-------------|-----------|
| WORKSTOOL 10 SERIES (WS) | WS10 – WS16 | 115 – 117 |
| WORKSTOOL 20 SERIES (WS) | WS22 – WS25 | 118, 119  |
| CLASSIC SPECIALTY STOOLS | CLFT, CLVS  | 105, 106  |

**about OM  
(p. 122)**

|                                 |     |
|---------------------------------|-----|
| Terms & Conditions              | 123 |
| Limited Warranty                | 124 |
| GSA Contract Information        | 125 |
| Environmental Mission Statement | 126 |
| Guide To Ergonomic Features     | 127 |

**fabrics, COM's, & grade-in options  
(p.129)**

|  |         |
|--|---------|
| COM, COL & Grade-in Information & Specifications | 130     |
| Guide To Grade-In Program & Grade-In Lists       | 131-135 |
| Upholstery                                       | 132-135 |

**arms, casters, & cylinder options  
(p.137)**

|                                 |         |
|---------------------------------|---------|
| Arm Matrix                      | 138     |
| Optional Arm Kits, Group 1      | 139-141 |
| Optional Arm Kits, Group 4      | 142     |
| Arm Top for Groups 1 & 4        |         |
| Arm Pads for Groups 1 & 4       | 143     |
| Caster Options and Guidelines   | 146     |
| Cylinder Options and Guidelines | 147     |

**additional upholstery and options**

|                                   |     |
|-----------------------------------|-----|
| Additional Upholstery and Options | 149 |
|-----------------------------------|-----|

Please be advised that all prices listed herein are shown at list price, subject to change without notification and do NOT include: assembly charge, installation charge, set-up charge, additional delivery charges or other charges exclusive of the cost of product.

# table of contents

by category (type)

## BY CATEGORY (type)

### **budget**

|                                  |               |         |
|----------------------------------|---------------|---------|
| BC SERIES (BC)                   | BC41 – BC99   | 19 – 25 |
| CLASSIC PROFESSIONAL SERIES (CL) | CL33 – CL48EZ | 29 – 31 |
| PARAMOUNT VALUE SERIES (PT)      | PT62 – PTYM   | 65 – 71 |
| PARAMOUNT VALUE SERIES (7XXX)    | 7770 – 7897   | 72 – 73 |
| PATRIOT VALUE SERIES (PA)        | PA53 – PA69   | 75 – 79 |
| PC SERIES (PC)                   | PC53 – PC59   | 80, 81  |

### **ergonomic**

|                                  |                  |         |
|----------------------------------|------------------|---------|
| AFFIRM SERIES (AF)               | AF504 – AF516S   | 9 – 17  |
| CONFERENCE EXECUTIVE SERIES (CE) | CE88 – CE89      | 27, 28  |
| DISCOVERY BACK SERIES (DB)       | DB52 – DB78      | 37 – 41 |
| OM5                              | OM5-B, OM5-G     | 53, 55  |
| OM5EX                            | OM5-BEX, OM5-GEX | 56, 57  |
| OM5XT                            | OM5-BXT, OM5-GXT | 58, 59  |
| PC SERIES (PC)                   | PC53 – PC59      | 80, 81  |
| PARAMOUNT VALUE SERIES (PT)      | PT62-PTYM        | 65 – 71 |
| PARAMOUNT VALUE SERIES (7XXX)    | 7770 – 7897      | 72 – 73 |
| YES SERIES (YS)                  | YS84 – YS89      | 83 – 86 |

### **mesh or plastic back**

|                             |                                |           |
|-----------------------------|--------------------------------|-----------|
| AFFIRM SERIES (AF)          | AF504 – AF589                  | 9 – 17    |
| OM5                         | OM5-B, OM5-G                   | 53, 55    |
| OM5EX                       | OM5-BEX, OM5-GEX               | 56, 57    |
| OM5XT                       | OM5-BXT, OM5-GXT               | 58, 59    |
| OM5 ACTIVE SERIES           | OM5-AT, OM5-AS, OM5-AG, OM5-AC | 95 – 103  |
| STACKABLE GUEST SERIES (SG) | SG1K – SG5K                    | 107 – 110 |
| STACKING CHAIRS (ST)        | ST200 – ST200C, ST400 – ST_    | 111 – 113 |
| YES SERIES (YS)             | YS70N – YSYM                   | 83 – 87   |

### **side/stack**

|                             |                            |           |
|-----------------------------|----------------------------|-----------|
| AFFIRM SERIES (AF)          | AF511S, AF516S             | 16        |
| BC SERIES (BC)              | BC48S, BC86S, BC98S        | 24        |
| OM5 ACTIVE STACKER          | OM5-AS                     | 98, 99    |
| OM5 ACTIVE GUEST            | OM5-AG                     | 100, 101  |
| PACIFIC (9XXX)              | 9100S, 9101S               | 63        |
| PARAMOUNT VALUE SERIES (PT) | PT70N, PT76S, PT74S, PT78S | 70        |
| PATRIOT VALUE SERIES (PA)   | PA61S                      | 79        |
| STACKABLE GUEST SERIES (SG) | SG1K – SG5K                | 107 – 110 |
| STACKING CHAIRS (ST)        | ST200 – ST400F             | 111 – 113 |
| YES SERIES (YS)             | YS71S, YS76S               | 83 – 87   |

### **stools**

|   |                        |          |
|---|------------------------|----------|
| AFFIRM SERIES (AF)                                | AF513, AF515           | 16       |
| BC SERIES (BC)                                    | BC41, BC45, BC47, BC49 | 19 – 25  |
| CLASSIC LAB & HEALTHCARE (CL)                     | CL12 – CL35            | 29 – 31  |
| CLASSIC PROFESSIONAL SERIES (CL)                  | CL44EZ, CL48EZ         | 32, 33   |
| CLASSIC LAB STOOLS (CLS)                          | CLS53 – CLS61          | 35, 36   |
| CLASSIC SPECIALTY STOOLS                          | CLFT, CLVS             | 105, 106 |
| DISCOVERY BACK SERIES (DB)                        | DB52, DB54, DB56       | 40       |
| OM5   | OM5-B, OM5-G           | 53 – 55  |
| OM5EX   | OM5-BEX, OM5-GEX       | 56, 57   |
| OM5XT   | OM5-BXT, OM5-GXT       | 58, 59   |
| OM5 ACTIVE CAFÉ STOOL                             | OM5-AC                 | 102, 103 |
| INTENSIVE USE 24-SEVEN SERIES (IU)                | IU55, IU73             | 45       |
| INTENSIVE USE 24-SEVEN 'HEAVY DUTY' SERIES (IUHD) | IU77HD, IU77PD         | 47       |
| MAXWELL INTENSIVE USE 24-SEVEN SERIES (MXIU)      | MX85IU, MX87IU         | 51       |
| WORKSTOOL 10 SERIES (WS)                          | WS15, WS15VS, WS16     | 117      |
| WORKSTOOL 20 SERIES (WS)                          | WS23, WS25             | 118      |
| YES SERIES (YS)                                   | YS73, YS75             | 86       |

## BY FUNCTION (control function)

### task

|                                    |               |         |
|------------------------------------|---------------|---------|
| AFFIRM SERIES (AF)                 | AF504 – AF589 | 9 – 17  |
| CLASSIC PROFESSIONAL SERIES (CL)   | CLS53 – CLS61 | 36      |
| DISCOVERY BACK SERIES (DB)         | DB52 – DB78   | 37 – 41 |
| INTENSIVE USE 24-SEVEN SERIES (IU) | IU54 – IU76   | 43 – 45 |
| PATRIOT VALUE SERIES (PA)          | PA53, PA59    | 75 – 79 |
| YES SERIES (YS)                    | YS72          | 84      |

### multi-function

|                             |                        |         |
|-----------------------------|------------------------|---------|
| AFFIRM SERIES (AF)          | AF584 – AF589          | 12, 15  |
| DISCOVERY BACK SERIES (DB)  | DB74, DB78             | 39      |
| PC SERIES (PC)              | PC53 – PC59            | 80, 81  |
| PARAMOUNT VALUE SERIES (PT) | PT62 – PTYM            | 65 – 69 |
| YES SERIES (YS)             | YS84, YS88, YS89, YSYM | 83 – 86 |

### basic task (simple function)

|                                  |                 |           |
|----------------------------------|-----------------|-----------|
| BC SERIES (BC)                   | BC41 – BC99     | 19 – 25   |
| CLASSIC PROFESSIONAL SERIES (CL) | CL44EZ – CL48EZ | 32, 33    |
| PACIFIC SERIES (9XXX)            | 9100 – 9200     | 61 – 63   |
| WORKSTOOL 10 SERIES (WS)         | WS10 – WS16     | 115 – 117 |
| WORKSTOOL 20 SERIES (WS)         | WS22 – WS25     | 118       |

### body-activated motion (self-weighting)

|                                  |  |         |
|----------------------------------|--|---------|
| CONFERENCE EXECUTIVE SERIES (CE) | CE88 – CE89  | 27, 28  |
| OM5 SERIES® & OM5 ACTIVE         | OM5-B, OM5-G, OM5-BEX,<br>OM5-GE, OM5-BXT, OM5-GXT | 53 – 59 |

### synchronized-tilt

|                    |                  |            |
|--------------------|------------------|------------|
| AFFIRM SERIES (AF) | AF504 – AF529    | 10, 12, 14 |
| YES SERIES (YS)    | YS74, YS78, YS79 | 84, 85     |
| ZESTA SERIES (ZA)  | ZA62, ZA66       | 89, 90     |

## IN ALPHABETICAL ORDER

|  |                               |           |
|--|-------------------------------|-----------|
| AFFIRM SERIES (AF)   | AF504 – AF589                 | 9 – 17    |
| BC SERIES (BC)   | BC41 – BC99                   | 19 – 25   |
| CONFERENCE EXECUTIVE SERIES (CE)                           | CE88 – CE89                   | 27, 28    |
| CLASSIC PROFESSIONAL SERIES (CL)                           | CL12 – CL48EZ                 | 29 – 33   |
| CLASSIC LAB STOOLS (CLS)                                   | CLS53 – CLS61                 | 35, 36    |
| CLASSIC SPECIALTY STOOLS                                   | CLFT, CLVS                    | 105, 106  |
| DISCOVERY BACK SERIES (DB)                                 | DB52 – DB78                   | 37 – 41   |
| INTENSIVE USE 24-SEVEN SERIES (IU)                         | IU54 – IU76                   | 43 – 45   |
| INTENSIVE USE 24-SEVEN 'HEAVY DUTY'<br>SERIES (IUHD, IUPD) | IU76HD/PD – IU79HD/PD         | 46, 47    |
| MAXWELL INTENSIVE USE 24-SEVEN (MXIU)                      | MX84IU/PD – MX88IU/PD, 7878MX | 49 – 51   |
| OM5  | OM5-B, OM5-G                  | 53 – 55   |
| OM5EX  | OM5-BEX, OM5-GEX              | 56, 57    |
| OM5XT  | OM5-BXT, OM5-GXT              | 58, 59    |
| OM5 ACTIVE TASKER  | OM5-AT                        | 96, 97    |
| OM5 ACTIVE STACKER   | OM5-AS                        | 98, 99    |
| OM5 ACTIVE GUEST   | OM5-AG                        | 100, 101  |
| OM5 ACTIVE CAFÉ STOOL                                      | OM5-AC                        | 102, 103  |
| PACIFIC SERIES (9XXX)                                      | 9100 – 9200                   | 61 – 63   |
| PARAMOUNT VALUE SERIES (PT)                                | PT62 – PTYM                   | 65 – 71   |
| PARAMOUNT SERIES (7XXX)                                    | 7770 – 7897                   | 72, 73    |
| PATRIOT VALUE SERIES (PA)                                  | PA53 – PA69                   | 75 – 79   |
| PC SERIES (PC)   | PC53 – PC59                   | 80, 81    |
| STACKABLE GUEST SERIES (SG)                                | SG1K – SG5K                   | 107 – 110 |
| STACKING CHAIRS (ST)                                       | ST200 – ST400F                | 111 – 113 |
| WORKSTOOL SERIES (WS)                                      | WS10 – WS25                   | 115 – 119 |
| YES SERIES (YS)  | YS70N – YSYM                  | 83 – 87   |
| ZESTA SERIES (ZA)  | ZA62 – ZA98                   | 89 – 91   |

# what's new

new product additions and changes to our offering

| STATUS       | ITEM MODEL              | REF. PAGE | DESCRIPTION<br>REMARKS AND COMPARABLE MODELS (IF APPLICABLE)  |
|--------------|-------------------------|-----------|---|
| NEW          | 7878MX                  | 51        | <b>7878MX</b> – Maxwell intensive-use heavy-duty alternate version with the 7878's executive back styling   |
| NEW          | AFFIRM SERIES           | 9         | <b>AF Series</b> – New series of modern, "frameless" mesh back chairs with a myriad of control options and back upholstery options (including a fully upholstered backrest alternative) |
| NEW          | CL44MD                  | 32        | <b>CL44MD</b> – Ultra-simple doctor's exam room "charting chair"  |
| NEW          | DB54                    | 40        | <b>DB54</b> – New Discovery Back stool with the small/medium backrest size and a turn-lock footing package.   |
| NEW          | MX85IU, MX87IU          | 51        | <b>MX85IU, MX87IU</b> – Stool versions of our heavy-duty Maxwell Intensive-Use series. Features a default 6" Super Heavy-Duty cylinder and an extra-wide footing and base.              |
| NEW          | OM5 ACTIVE SERIES       | 93        | <b>OM5 Active</b> – Sled, 4-leg, 5-star, Café Stool "occasional use" seating – sub-family of the innovative OM5 Series®   |
| NEW          | PA6x SERIES             | 66        | <b>PA6x Series</b> – Synchronized Tilting versions of the popular PA Series and PC Series chairs.   |
| NEW          | PT70N, PT76S            | 70        | <b>PT70N, PT76S</b> – Upholstered Nesting chair and alternative to PT78S, respectively. The PT76S comes armless, but can accept any Group 1 & 4 arms!                                   |
| NEW          | SG1K, SG5K              | 106, 108  | <b>SG1K, SG5K</b> – Armless version of SG2K, and mesh-back 4-legged side chair, respectively.   |
| NEW          | WS16                    | 115       | <b>WS16</b> – Alternative to WS15 sit/stand stool. Easy-to-clean, self-skin urethane with convenient built-in handle.   |
| NEW          | YS71N, YSYM             | 86, 87    | <b>YS71N, YSYM</b> – Armless version of popular YS70N nesting chair, and deep-seat (i.e., tall person) version of YS88, respectively.   |
| NEW          | AR11 ARMS               | 16        | <b>AR11 Arms</b> – Fixed cantilever arms with a self-skin PU overmold (option for Affirm Series)  |
| NEW          | JR49 ARMS               | 142       | <b>JR49 Arms</b> – Forward-slanting arms with "RP45" multi-directional, free-float arm top  |
| NEW          | JR59 ARMS               | 142       | <b>JR59 Arms</b> – Forward-slanting arms with "RP50" ultra-adjustable free-float arm top  |
| NEW          | JR69 ARMS               | 142       | <b>JR69 Arms</b> – Forward-slanting arms with "RP65" multi-directional, 4D <i>lockable</i> arm top  |
| NEW          | KR465, KR200-65,        | 121, 122  | <b>KR465, KR200-65, KR300-65</b> – Height/Width adjustable, removable T-arms with "RP65"  |
| NEW          | KR300-65 ARMS           |           | multi-directional, 4D <i>lockable</i> arm top   |
| NEW          | RP65 ARM TOP            | 124       | <b>RP65 Arm Top</b> – Multi-directional, 4D, lockable arm top   |
| IMPROVED     | BC85                    | 21        | <b>BC85</b> – Now featuring a simple synchronized tilt mechanism with a 1-position lockout.   |
| IMPROVED     | MXIU                    | 49        | <b>MX Series</b> – Entire series' weight rating has been boosted from 400 lbs. (previous) to 450 lbs.!  |
| IMPROVED     | OM5 SERIES® OPTIONS     | 53        | <b>UPHCFT</b> – Known as the "Cush For Tush" option. Sub-layer of memory foam for added OM5 Series® seat comfort (also available for OM5 Active and Affirm Series)                      |
| IMPROVED     | OM Seat Depth (Slider)  | 53        | <b>OM Seat Depth (Slider)</b> – New seat depth range of 3.1" fit an even greater percent of user populations.   |
| IMPROVED     | YS8x                    | 84, 85    | <b>YS8x</b> – Management mesh models' weight rating has been boosted from 250 lbs. (previous) to 300 lbs.!  |
| PHASE OUT    | RECEPTION/3000 SERIES - |           | <b>3000, 3001, 3002 Reception Room Series</b> is not shown in book and being phased out. Call OM for pricing and details.   |
| DISCONTINUED | VARIOUS CYLINDERS -     |           | <b>CYL-3, CYL-4, CYL-7TC, CYL-8CR, CYL-10CR</b> – Respectively replaced by CYL-4HD, CYL-4HD, CYL-5HD, CYL-6SHD, CYL-8CHD, CYL-10CHD   |

**Need help selecting the right OM model for your customer?**

**Remember though, while we hope this guide is helpful and even a little fun to use, choosing the right chair can not be done on the basis of price or the number of features alone. Proper ergonomics, safety and comfort are all additional important considerations that your customer should weigh equally in making their seating purchase decision.**

OM has developed this Price-to-Features Matrix to help you get started in the right direction. Use it to pick an OM model family with the price-to-features profile that most closely matches your customer's needs. Then, to further refine their selection, call on our experienced factory reps and customer service team to arrange samples or find additional information. You can also visit our website for product images, news and updated specifications ([omsmartseating.com](http://omsmartseating.com)).

**Specialty Seating Starting Points**

|                        |  |
|------------------------|--|
| Task                   | PA or Patriot or PC or Affirm Series                                 |
| Temporary Seating      | ST or SG Series or OM5 Active  |
| Ultra-Ergonomic        | DB Series or OM5 Series  |
| Hospital               | CL Stool Series & DB Series or OM5 Series                            |
| Police & Call Centers  | IUHD or IUPD Series Or MXIU or MXPD                                  |
| Conference & Executive | YS or Pacific Series or CE Conference or OM5 Series or Affirm Series |
| Ergonomic Management   | PT Series or Paramount Series or OM5 Series or PC                    |

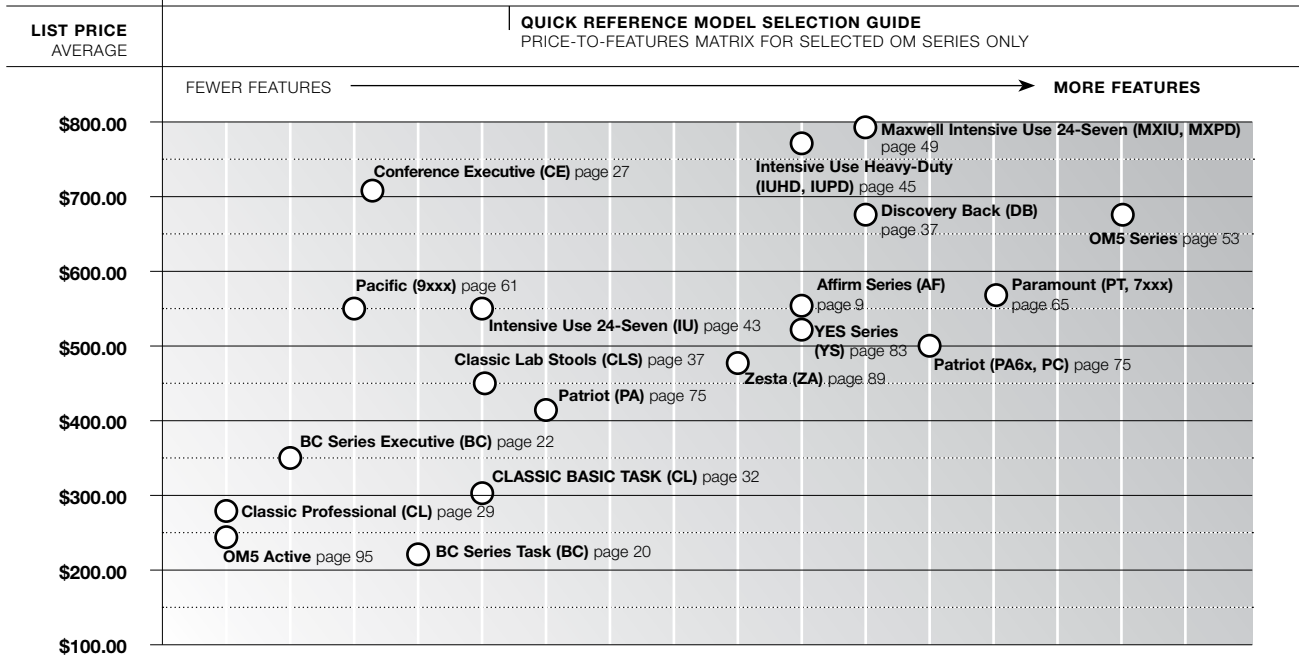

## seating technology for comfort

**DCS™ TECHNOLOGY**  
Double Comfort Seating Technology



OM's Double Comfort Seating™ (DCS) Technology is a unique layered system of self-conforming memory foam, combined with firmer OM high-resilience cushioning. Years of research and development have resulted in a seating experience that is at once soft and supportive, and truly beyond compare.

By combining German and Japanese process technologies and formulas for molding cushions, OM is able to create a medical-grade seat cushion that provides even more support than our standard high-resilience seat cushion. This additional support comes with the added benefit of a body-conforming seat which allows users to remain comfortably seated for longer periods of time.

The DCS™ Technology seat cushion has achieved excellent results when put through a series of 'seating durability' tests. The seat cushion will withstand the rigors of every day stress and wear while remaining comfortable and supportive.

**BAM**  
Body-activated motion

Body-activated Motion (BAM) describes the dynamic ergonomic principals that the OM5 Series® of seating rides on.

Instead of relying on inconvenient manual adjustments that many chair occupants realistically rarely use (or worse: misuse), the OM5 Series® dynamically adapts to the user; reclining or pausing in immediate response to cues from the user's own body.



notes

Lined area for notes with 25 horizontal lines.



## features:

Begins @ \$438 armless / \$547 with KR-200 (AF504)

Flexible options ideal for task, executive, and conference environments

Contemporary, "frameless", rectilinear design

Multiple mesh color (two) and knitted upholstery jacket (nine) options

Seat designed with extra waterfall curve and "sit-as-you-like" comfort

→  
Use our  
handy  
stickers to  
mark this  
section.  
affirm series  
(AF)



**AF529**

Pictured here with optional JR-69 arms  
and C.O.M. Arcitex Dakar Rally upholstery  
\$880.00 List (at Grade 1/C.O.M.)



**AF524**

Pictured here with optional JR-69 arms  
and C.O.M. Maharam Divina 106 upholstery  
\$772.00 List (at Grade 1/C.O.M.)



**AF504**

Pictured here with optional JR-49 arms  
and C.O.M. Maharam Repeat Dot Ring 012  
Robin Reverse upholstery  
\$624.00 List (at Grade 1/C.O.M.)

# affirm series (AF)

conference | boardroom | executive task

Please see pages 138 - 149 for arm kits, casters and options (i.e., over 30 arm rest options for a broad range of users/needs).

average / mid back

## Model

AF504



## Description

### Simple mid-back

- Pneumatic lift
- EZ back height adjustment
- Synchronous seat/back tilt
- "Frameless" mesh back design
- Seat depth adjustment
- 1-stage locking tilt**
- Night Fall black mesh is default

## Textile Grade-In

- Grade 1 / C.O.M. \$438.00
- Grade 2 / Grade-in A \$448.00
- Grade 3 / Grade-in B \$458.00
- Grade 4 / Grade-in C \$468.00
- Grade 5 / Grade-in D \$478.00
- Grade 6 / Grade-in E \$488.00
- Evita leather (Black/White/Stone/Vanilla) \$563.00

## List

## Specifications

- Overall width 27"
- Overall height 38.25" - 45.75"
- Back 19.75" w x 20.5" h
- Seat 20.5" w x 17.5-20.6" d
- Seat height 17" - 22"
- COM 1 yd.
- Carton weight 57 pounds
- UPS weight 101 pounds
- Arms Groups AR, 1 & 4
- Warranty 12 year limited

## Model

AF514



## Description

### Management mid-back

- Pneumatic lift
- EZ back height adjustment
- 3-stage locking tilt**
- Synchronous seat/back tilt
- "Frameless" mesh back design
- Seat depth adjustment
- Night Fall black mesh is default

## Textile Grade-In

- Grade 1 / C.O.M. \$498.00
- Grade 2 / Grade-in A \$508.00
- Grade 3 / Grade-in B \$518.00
- Grade 4 / Grade-in C \$528.00
- Grade 5 / Grade-in D \$538.00
- Grade 6 / Grade-in E \$548.00
- Evita leather (Black/White/Stone/Vanilla) \$623.00

## List

## Specifications

- Overall width 27"
- Overall height 38.25" - 45.75"
- Back 19.75" w x 20.5" h
- Seat 20.5" w x 17.5-20.6" d
- Seat height 17" - 22"
- COM 1 yd.
- Carton weight 57 pounds
- UPS weight 101 pounds
- Arms Groups AR, 1 & 4
- Warranty 12 year limited

## Model

AF524



## Description

### Executive mid-back

- Pneumatic lift
- EZ back height adjustment
- Synchronous seat/back tilt
- "Frameless" mesh back design
- Seat depth adjustment
- 5-stage locking tilt**
- Independent back tilt**
- Side-mounted tension knob**
- Night Fall black mesh is default

## Textile Grade-In

- Grade 1 / C.O.M. \$566.00
- Grade 2 / Grade-in A \$576.00
- Grade 3 / Grade-in B \$586.00
- Grade 4 / Grade-in C \$596.00
- Grade 5 / Grade-in D \$606.00
- Grade 6 / Grade-in E \$616.00
- Evita leather (Black/White/Stone/Vanilla) \$691.00

## List

## Specifications

- Overall width 27"
- Overall height 38.25" - 45.75"
- Back 19.75" w x 20.5" h
- Seat 20.5" w x 17.5-20" d
- Seat height 17" - 22"
- COM 1 yd.
- Carton weight 57 pounds
- UPS weight 101 pounds
- Arms Groups AR, 1 & 4
- Warranty 12 year limited

Arms are optional. Polished aluminum package default on AF528 & AF529 only. Neighborhood back upholstery optional.

conference | boardroom | executive task

# affirm series (AF)

Please see pages 138 - 149 for arm kits, casters and options (i.e., over 30 arm rest options for a broad range of users/needs).

average / mid back

**Model**

AF574



300 POUNDS CAPACITY

**Description**

**Task mid-back**

- Pneumatic lift
- EZ back height adjustment
- Independent seat and back angle adjustment
- Seat depth adjustment
- Night Fall black mesh is default

**Textile Grade-In**

- Grade 1 / C.O.M. \$487.00
- Grade 2 / Grade-in A \$497.00
- Grade 3 / Grade-in B \$507.00
- Grade 4 / Grade-in C \$517.00
- Grade 5 / Grade-in D \$527.00
- Grade 6 / Grade-in E \$537.00
- Evita leather (Black/White/Stone/Vanilla) \$612.00

**List**

**Specifications**

- Overall width 27"
- Overall height 38.25" - 45.75"
- Back 19.75" w x 20.5" h
- Seat 20.5" w x 17.5-20.6" d
- Seat height 17" - 22"
- COM 1 yd.
- Carton weight 57 pounds
- UPS weight 101 pounds
- Arms Groups AR, 1 & 4
- Warranty 12 year limited

**Model**

AF584



300 POUNDS CAPACITY

**Description**

**Multi-function mid-back**

- Pneumatic lift
- Tilting backrest
- EZ back height adjustment
- Seat tilting
- Seat depth adjustment
- Rocking tilt
- Infinite forward tilting
- Night Fall black mesh is default

**Textile Grade-In**

- Grade 1 / C.O.M. \$514.00
- Grade 2 / Grade-in A \$524.00
- Grade 3 / Grade-in B \$534.00
- Grade 4 / Grade-in C \$544.00
- Grade 5 / Grade-in D \$554.00
- Grade 6 / Grade-in E \$564.00
- Evita leather (Black/White/Stone/Vanilla) \$639.00

**List**

**Specifications**

- Overall width 27"
- Overall height 38.25" - 45.75"
- Back 19.75" w x 20.5" h
- Seat 20.5" w x 17.5-20.6" d
- Seat height 17" - 22"
- COM 1 yd.
- Carton weight 57 pounds
- UPS weight 101 pounds
- Arms Groups AR, 1 & 4
- Warranty 12 year limited

Arms are optional. Polished aluminum package standard on AF528 & AF529 only. Neighborhood back upholstery optional.

# affirm series (AF)

conference | boardroom | executive task

Please see pages 138 - 149 for arm kits, casters and options (i.e., over 30 arm rest options for a broad range of users/needs).

high back

## Model

### AF508



300  
POUNDS  
CAPACITY

## Description

### Simple high-back

Pneumatic lift  
EZ back height adjustment  
3-stage locking tilt  
Synchronous seat/back tilt  
"Frameless" mesh back design  
Seat depth adjustment  
**1-stage locking tilt**  
Night Fall black mesh is default

## Textile Grade-In

Grade 1 / C.O.M. \$471.00  
Grade 2 / Grade-in A \$481.00  
Grade 3 / Grade-in B \$491.00  
Grade 4 / Grade-in C \$501.00  
Grade 5 / Grade-in D \$511.00  
Grade 6 / Grade-in E \$521.00  
Evita leather  
(Black/White/Stone/Vanilla) \$596.00

## List

## Specifications

Overall width 27"  
Overall height 41.5" - 49"  
Back 21" w x 24" h  
Seat 20.5" w x 17.5-20.6" d  
Seat height 17" - 22"  
COM 1 yd.  
Carton weight 58 pounds  
UPS weight 101 pounds  
Arms Groups AR, 1 & 4  
Warranty 12 year limited

## Model

### AF518



300  
POUNDS  
CAPACITY

## Description

### Management high-back

Pneumatic lift  
EZ back height adjustment  
3-stage locking tilt  
**Side-mounted tension knob**  
Synchronous seat/back tilt  
"Frameless" mesh back design  
Seat depth adjustment  
Night Fall black mesh is default

## Textile Grade-In

Grade 1 / C.O.M. \$531.00  
Grade 2 / Grade-in A \$541.00  
Grade 3 / Grade-in B \$551.00  
Grade 4 / Grade-in C \$561.00  
Grade 5 / Grade-in D \$571.00  
Grade 6 / Grade-in E \$581.00  
Evita leather  
(Black/White/Stone/Vanilla) \$656.00

## List

## Specifications

Overall width 27"  
Overall height 41.5" - 49"  
Back 21" w x 24" h  
Seat 20.5" w x 17.5-20.6" d  
Seat height 17" - 22"  
COM 1 yd.  
Carton weight 58 pounds  
UPS weight 101 pounds  
Arms Groups AR, 1 & 4  
Warranty 12 year limited

## Model

### AF528



300  
POUNDS  
CAPACITY

## Description

### Executive high-back

Pneumatic lift  
EZ back height adjustment  
Synchronous seat/back tilt  
"Frameless" mesh back design  
Seat depth adjustment  
**Independent back tilt**  
**5-stage locking tilt**  
**Side-mounted tension knob**  
Night Fall black mesh is default

## Textile Grade-In

Grade 1 / C.O.M. \$599.00  
Grade 2 / Grade-in A \$609.00  
Grade 3 / Grade-in B \$619.00  
Grade 4 / Grade-in C \$629.00  
Grade 5 / Grade-in D \$639.00  
Grade 6 / Grade-in E \$649.00  
Evita leather  
(Black/White/Stone/Vanilla) \$724.00

## List

## Specifications

Overall width 27"  
Overall height 41.5" - 49"  
Back 21" w x 24" h  
Seat 20.5" w x 17.5-20.6" d  
Seat height 17" - 22"  
COM 1 yd.  
Carton weight 58 pounds  
UPS weight 101 pounds  
Arms Groups AR, 1 & 4  
Warranty 12 year limited

Arms are optional. Polished aluminum package default on AF528 & AF529 only. Neighborhood back upholstery optional.

conference | boardroom | executive task

# affirm series (AF)

Please see pages 138 - 149 for arm kits, casters and options (i.e., over 30 arm rest options for a broad range of users/needs).

high back

**Model**

AF578



**Description**

**Task high-back**

- Pneumatic lift
- EZ back height adjustment
- Independent seat and back angle adjustment
- Seat depth adjustment
- Night Fall black mesh is default

**Textile Grade-In**

- Grade 1 / C.O.M. \$520.00
- Grade 2 / Grade-in A \$530.00
- Grade 3 / Grade-in B \$540.00
- Grade 4 / Grade-in C \$550.00
- Grade 5 / Grade-in D \$560.00
- Grade 6 / Grade-in E \$570.00
- Evita leather (Black/White/Stone/Vanilla) \$645.00

**List**

**Specifications**

- Overall width 27"
- Overall height 41.5" - 49"
- Back 21" w x 24" h
- Seat 20.5" w x 17.5-20.6" d
- Seat height 17" - 22"
- COM 1 yd.
- Carton weight 58 pounds
- UPS weight 101 pounds
- Arms Groups AR, 1 & 4
- Warranty 12 year limited

**Model**

AF588



**Description**

**Multi-function high-back**

- Pneumatic lift
- Tilting backrest
- EZ back height adjustment
- Seat tilting
- Seat depth adjustment
- Rocking tilt
- Infinite forward tilting
- Night Fall black mesh is default

**Textile Grade-In**

- Grade 1 / C.O.M. \$547.00
- Grade 2 / Grade-in A \$557.00
- Grade 3 / Grade-in B \$567.00
- Grade 4 / Grade-in C \$577.00
- Grade 5 / Grade-in D \$587.00
- Grade 6 / Grade-in E \$597.00
- Evita leather (Black/White/Stone/Vanilla) \$672.00

**List**

**Specifications**

- Overall width 27"
- Overall height 41.5" - 49"
- Back 21" w x 24" h
- Seat 20.5" w x 17.5-20.6" d
- Seat height 17" - 22"
- COM 1 yd.
- Carton weight 58 pounds
- UPS weight 101 pounds
- Arms Groups AR, 1 & 4
- Warranty 12 year limited

Arms are optional. Polished aluminum package standard on AF528 & AF529 only. Neighborhood back upholstery optional.

# affirm series (AF)

conference | boardroom | executive task

Please see pages 138 - 149 for arm kits, casters and options (i.e., over 30 arm rest options for a broad range of users/needs).

high back with headrest

## Model

AF509



300  
POUNDS  
CAPACITY

## Description

**Simple high-back & mesh head rest\***

Pneumatic lift  
EZ back height adjustment  
Synchronous seat/back tilt  
"Frameless" mesh back design  
Seat depth adjustment

**1-stage locking tilt**

Night Fall black mesh is default

## Textile Grade-In

Grade 1 / C.O.M. \$546.00  
Grade 2 / Grade-in A \$556.00  
Grade 3 / Grade-in B \$566.00  
Grade 4 / Grade-in C \$576.00  
Grade 5 / Grade-in D \$586.00  
Grade 6 / Grade-in E \$596.00  
Evita leather  
(Black/White/Stone/Vanilla) \$671.00

## List

## Specifications

Overall width 27"  
Overall height 47" - 58"  
Back 21" w x 24" h  
Seat 20.5" w x 17.5-20.6" d  
Seat height 17" - 22"  
COM 1 yd.  
Carton weight 59 pounds  
UPS weight 101 pounds  
Arms Groups AR, 1 & 4  
Warranty 12 year limited

## Model

AF519



300  
POUNDS  
CAPACITY

## Description

**Management high-back & mesh head rest\***

Pneumatic lift  
EZ back height adjustment  
3-stage locking tilt

**Side-mounted tension knob**

Synchronous seat/back tilt  
"Frameless" mesh back design  
Seat depth adjustment

Night Fall black mesh is default

## Textile Grade-In

Grade 1 / C.O.M. \$606.00  
Grade 2 / Grade-in A \$616.00  
Grade 3 / Grade-in B \$626.00  
Grade 4 / Grade-in C \$636.00  
Grade 5 / Grade-in D \$646.00  
Grade 6 / Grade-in E \$656.00  
Evita leather  
(Black/White/Stone/Vanilla) \$731.00

## List

## Specifications

Overall width 27"  
Overall height 47" - 58"  
Back 21" w x 24" h  
Seat 20.5" w x 17.5-20.6" d  
Seat height 17" - 22"  
COM 1 yd.  
Carton weight 59 pounds  
UPS weight 101 pounds  
Arms Groups AR, 1 & 4  
Warranty 12 year limited

## Model

AF529



300  
POUNDS  
CAPACITY

## Description

**Executive high-back & mesh head rest\***

Pneumatic lift  
EZ back height adjustment  
Synchronous seat/back tilt  
"Frameless" mesh back design  
Seat depth adjustment

**Independent back tilt**

**5-stage locking tilt**

**Side-mounted tension knob**

Night Fall black mesh is default

## Textile Grade-In

Grade 1 / C.O.M. \$674.00  
Grade 2 / Grade-in A \$684.00  
Grade 3 / Grade-in B \$694.00  
Grade 4 / Grade-in C \$704.00  
Grade 5 / Grade-in D \$714.00  
Grade 6 / Grade-in E \$724.00  
Evita leather  
(Black/White/Stone/Vanilla) \$799.00

## List

## Specifications

Overall width 27"  
Overall height 47" - 58"  
Back 21" w x 24" h  
Seat 20.5" w x 17.5-20" d  
Seat height 17" - 22"  
COM 1 yd.  
Carton weight 59 pounds  
UPS weight 101 pounds  
Arms Groups AR, 1 & 4  
Warranty 12 year limited

\* Optional Evita leather upholstered headrest option HR-YSL - Add \$28.00 to list.

Arms are optional. Polished aluminum package default on AF528 & AF529 only. Neighborhood back upholstery optional.

conference | boardroom | executive task

# affirm series (AF)

Please see pages 138 - 149 for arm kits, casters and options (i.e., over 30 arm rest options for a broad range of users/needs).

high back with headrest

**Model**

AF579



**Description**

- Task high-back & mesh head rest\***
- Pneumatic lift
- EZ back height adjustment
- Independent seat and back angle adjustment
- Seat depth adjustment
- Night Fall black mesh is default

**Textile Grade-In**

- Grade 1 / C.O.M. \$595.00
- Grade 2 / Grade-in A \$605.00
- Grade 3 / Grade-in B \$615.00
- Grade 4 / Grade-in C \$625.00
- Grade 5 / Grade-in D \$635.00
- Grade 6 / Grade-in E \$645.00
- Evita leather (Black/White/Stone/Vanilla) \$720.00

**List**

**Specifications**

- Overall width 27"
- Overall height 47" - 58"
- Back 21" w x 24" h
- Seat 20.5" w x 17.5-20.6" d
- Seat height 17" - 22"
- COM 1 yd.
- Carton weight 59 pounds
- UPS weight 101 pounds
- Arms Groups AR, 1 & 4
- Warranty 12 year limited

**Model**

AF589



**Description**

- Multi-function high-back & mesh head rest\***
- Pneumatic lift
- Tilting backrest
- EZ back height adjustment
- Seat tilting
- Seat depth adjustment
- Rocking tilt
- Infinite forward tilting
- Night Fall black mesh is default

**Textile Grade-In**

- Grade 1 / C.O.M. \$622.00
- Grade 2 / Grade-in A \$632.00
- Grade 3 / Grade-in B \$642.00
- Grade 4 / Grade-in C \$652.00
- Grade 5 / Grade-in D \$662.00
- Grade 6 / Grade-in E \$672.00
- Evita leather (Black/White/Stone/Vanilla) \$747.00

**List**

**Specifications**

- Overall width 27"
- Overall height 47" - 58"
- Back 21" w x 24" h
- Seat 20.5" w x 17.5-20.6" d
- Seat height 17" - 22"
- COM 1 yd.
- Carton weight 59 pounds
- UPS weight 101 pounds
- Arms Groups AR, 1 & 4
- Warranty 12 year limited

\* Optional Evita leather upholstered headrest option HR-YSL - Add \$28.00 to list. ("Neighborhood Collection" upholstery NOT recommended on head rest)

Arms are optional. Polished aluminum package default on AF528 & AF529 only. Neighborhood back upholstery optional.

# affirm series (AF)

conference | boardroom | executive task

Please see pages 138 - 149 for arm kits, casters and options (i.e., over 30 arm rest options for a broad range of users/needs).

stools

| Model | Description                         | Stool | Textile Grade-In            | List     | Specifications              |
|-------|-------------------------------------|-------|-----------------------------|----------|-----------------------------|
| AF513 | <b>Simple mid-back stool</b>        |       | Grade 1 / C.O.M.            | \$528.00 | Overall width 27"           |
|       | Fixed foot ring                     |       | Grade 2 / Grade-in A        | \$538.00 | Overall height 46" - 57"    |
|       | Pneumatic lift                      |       | Grade 3 / Grade-in B        | \$548.00 | Back 19.75" w x 20.5" h     |
|       | EZ back height adjustment           |       | Grade 4 / Grade-in C        | \$558.00 | Seat 20.5" w x 18.5-21.6" d |
|       | <b>Infinitely locking back tilt</b> |       | Grade 5 / Grade-in D        | \$568.00 | Seat height 25" - 33"       |
|       | "Frameless" mesh back design        |       | Grade 6 / Grade-in E        | \$578.00 | COM 1 yd.                   |
|       | Seat depth adjustment               |       | Evita leather               |          | Carton weight 56 pounds     |
|       | Night Fall black mesh is default    |       | (Black/White/Stone/Vanilla) | \$653.00 | UPS weight 101 pounds       |
|       |                                     |       |                             |          | Arms Groups AR, 1 & 4       |
|       |                                     |       |                             |          | Warranty 12 year limited    |



| Model | Description                         | Stool | Textile Grade-In            | List     | Specifications              |
|-------|-------------------------------------|-------|-----------------------------|----------|-----------------------------|
| AF515 | <b>Simple mid-back stool</b>        |       | Grade 1 / C.O.M.            | \$614.00 | Overall width 27"           |
|       | <b>Adjustable foot ring</b>         |       | Grade 2 / Grade-in A        | \$624.00 | Overall height 46" - 59"    |
|       | Pneumatic lift                      |       | Grade 3 / Grade-in B        | \$634.00 | Back 19.75" w x 20.5" h     |
|       | EZ back height adjustment           |       | Grade 4 / Grade-in C        | \$644.00 | Seat 20.5" w x 18.5-21.6" d |
|       | <b>Infinitely locking back tilt</b> |       | Grade 5 / Grade-in D        | \$654.00 | Seat height 25.5" - 35.5"   |
|       | "Frameless" mesh back design        |       | Grade 6 / Grade-in E        | \$664.00 | COM 1 yd.                   |
|       | Seat depth adjustment               |       | Evita leather               |          | Carton weight 58 pounds     |
|       | Night Fall black mesh is default    |       | (Black/White/Stone/Vanilla) | \$739.00 | UPS weight 101 pounds       |
|       |                                     |       |                             |          | Arms Groups AR, 1 & 4       |
|       |                                     |       |                             |          | Warranty 12 year limited    |



guest

| Model  | Description                      | Guest | Textile Grade-In            | List     | Specifications             |
|--------|----------------------------------|-------|-----------------------------|----------|----------------------------|
| AF511S | <b>Mid-back guest</b>            |       | Grade 1 / C.O.M.            | \$311.00 | Overall width 24"          |
|        | "Frameless" mesh back design     |       | Grade 2 / Grade-in A        | \$321.00 | Overall height 40" (fixed) |
|        | Night Fall black mesh is default |       | Grade 3 / Grade-in B        | \$331.00 | Back 19.75" w x 20.5" h    |
|        |                                  |       | Grade 4 / Grade-in C        | \$341.00 | Seat 20.5" w x 18.5" d     |
|        |                                  |       | Grade 5 / Grade-in D        | \$351.00 | Seat height 18" (fixed)    |
|        |                                  |       | Grade 6 / Grade-in E        | \$361.00 | COM 1 yd.                  |
|        |                                  |       | Evita leather               |          | Carton weight 56 pounds    |
|        |                                  |       | (Black/White/Stone/Vanilla) | \$436.00 | UPS weight 101 pounds      |
|        |                                  |       |                             |          | Arms Groups AR, 1 & 4      |
|        |                                  |       |                             |          | Warranty 12 year limited   |



| Model  | Description                      | Guest | Textile Grade-In            | List     | Specifications               |
|--------|----------------------------------|-------|-----------------------------|----------|------------------------------|
| AF516S | <b>High-back guest</b>           |       | Grade 1 / C.O.M.            | \$351.00 | Overall width 25"            |
|        | "Frameless" mesh back design     |       | Grade 2 / Grade-in A        | \$361.00 | Overall height 42.5" (fixed) |
|        | Night Fall black mesh is default |       | Grade 3 / Grade-in B        | \$371.00 | Back 21" w x 24" h           |
|        |                                  |       | Grade 4 / Grade-in C        | \$381.00 | Seat 20.5" w x 18.5" d       |
|        |                                  |       | Grade 5 / Grade-in D        | \$391.00 | Seat height 18" (fixed)      |
|        |                                  |       | Grade 6 / Grade-in E        | \$401.00 | COM 1 yd.                    |
|        |                                  |       | Evita leather               |          | Carton weight 57 pounds      |
|        |                                  |       | (Black/White/Stone/Vanilla) | \$476.00 | UPS weight 101 pounds        |
|        |                                  |       |                             |          | Arms Groups AR, 1 & 4        |
|        |                                  |       |                             |          | Warranty 12 year limited     |









Arms are optional. Polished aluminum package default on AF528 & AF529 only. Neighborhood back upholstery optional.



Please see pages 138 - 149 for arm kits, casters and options (i.e., over 30 arm rest options for a broad range of users/needs).

common options

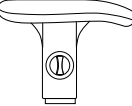
### Common Options for AF Series\*

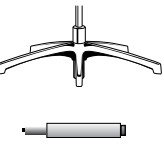
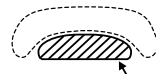
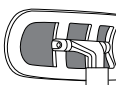
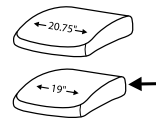
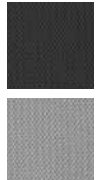
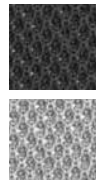
|  |  |  |
|--|--|--|
| <p><b>Arms kits</b></p>                                   | <p><b>AR-11</b> - list: 49.00<br/>Fixed height cantilever arm for Affirm Collection chairs (only)</p>  |  <p><b>KR-25</b> - list: 79.00<br/>Contoured height, adjustable T-arms featuring natural grip control. Adjustable height range = 2.75". 12 year limited warranty on the arm frame. 2 year limited warranty on the arm pad.</p>  |
|   | <p><b>JR-49</b> - list: 186.00<br/>RP45 arm pads. 2-way adjustable width/height. Forward-slanting T-arms with smooth fore-aft, side-side, and pivoting motion arm caps. Adjustable height-4.25". Adjustable width-1.75". 7 year limited warranty on the arm frame. 2 year limited warranty on the arm pad.</p> |  <p><b>KR-25M</b> - list: 111.00<br/>Contoured height, adjustable T-arms featuring memosoft arm pad. Adjustable height range = 2.75". 12 year limited warranty on the arm frame. 2 year limited warranty on the arm pad.</p>  |
|   | <p><b>KR-21</b> - list: 65.00<br/>Contoured height, adjustable T-arms. Adjustable height range = 2.25". 12 year limited warranty on the arm frame. 2 year limited warranty on the arm pad.</p>   |  <p><b>KR-445</b> - list: 175.00<br/>Width adjustable T-arms with smooth fore-aft, side-side, and pivoting motion arm caps. Adjustable height range of 2.75". Adjustable width range of approximately 1" per side. 12 year limited warranty on the arm frame. 2 year limited warranty on the arm pad.</p> |
| <p><b>Options</b></p>  | <p><b>Polished Aluminum Base &amp; 5" Chrome Cylinder Package</b><br/>list: 88.00<br/>(Default on AF528 and AF529)</p>   |  <p><b>UPHCFT</b> - list: 66.00<br/>Memory foam upholstery sub-layer (i.e., viscoelastic foam located underneath HR foam to preserve aesthetics while still enhancing sitting comfort)</p>   |
|   | <p><b>Evita Leather Upholstered Headrest</b><br/>list: add 28.00 to AF5x9 chair</p>  |  <p><b>SEATAF-S (small Affirm seat)</b> - list: N/C<br/>19" w x 17.5-20.6" d, smaller version of Affirm seat. Recommended for pairing with AF5x4 models (as needed).</p>  |
|   | <p><b>Mesh Color Option</b> - no charge<br/>Choose between Nightfall Black (default) or Starlight Silver</p>   |  <p><b>"Neighborhood Collection" Backrest Upholstery</b> - list: 58.00<br/>A breathable, knit overlay with 9 lively color choices. Please refer to the OM5 + Affirm Backrest Upholstery card.<br/><br/>Note: Neighborhood Collection fabric is not suitable for seat fabrics</p>                        |

\* See pages 138 to 149 for a complete listing of all available arm, cylinder, caster, and other ergonomic options.

\* Not all options may be applicable to a given model. Check with OM for compatibility details.

# affirm series (AF)

conference | boardroom | executive task

Please see pages 138 - 149 for arm kits, casters and options (i.e., over 30 arm rest options for a broad range of users/needs).

fully upholstered version (AF)



AF408-KR445 arms

## Fully Upholstered Backrest

### AFFIRM SERIES ALTERNATIVE VERSION

*Available Immediately.* The Affirm Series' contemporary mesh back design has been so appealing partly because of its rectilinear outline and range of mesh-related options.

But now we've added another exciting backrest option: A fully cushioned, fully upholstered rectilinear high-back option that can be used with any of the existing Affirm mechanisms. Simply order as an AF4x8, where the x indicates the mechanism style (i.e., '0', '1', '2', '7', '8'... see preceding pages 12-13 to cross-reference). For pricing, see below.

## Worksheet Fully Upholstered Backrest Affirm Comparison & Ordering Guide

| MODEL # | COMPARATIVE DESCRIPTION   | TEXTILE / GRADE-IN                        | PRICE    |
|---------|---|---|----------|
| AF408   | "Simple Synchro" chair with 1-lockout position (based on AF508)                                     | Grade 1 / COM                             | \$441.00 |
|         |   | Grade 2 / Grade-in A                      | \$456.00 |
|         |   | Grade 3 / Grade-in B                      | \$471.00 |
|         |   | Grade 4 / Grade-in C                      | \$486.00 |
|         |   | Grade 5 / Grade-in D                      | \$501.00 |
|         |   | Grade 6 / Grade-in E                      | \$516.00 |
|         |   | Evita Leather (Black/White/Stone/Vanilla) | \$691.00 |
| AF418   | "Management Synchro" chair with 3-lockout positions (based on AF518)                                | Grade 1 / COM                             | \$501.00 |
|         |   | Grade 2 / Grade-in A                      | \$516.00 |
|         |   | Grade 3 / Grade-in B                      | \$531.00 |
|         |   | Grade 4 / Grade-in C                      | \$546.00 |
|         |   | Grade 5 / Grade-in D                      | \$561.00 |
|         |   | Grade 6 / Grade-in E                      | \$576.00 |
|         |   | Evita Leather (Black/White/Stone/Vanilla) | \$751.00 |
| AF428   | "Executive Synchro" chair with 5-lockout positions (based on AF528)                                 | Grade 1 / COM                             | \$569.00 |
|         |   | Grade 2 / Grade-in A                      | \$584.00 |
|         |   | Grade 3 / Grade-in B                      | \$599.00 |
|         |   | Grade 4 / Grade-in C                      | \$614.00 |
|         |   | Grade 5 / Grade-in D                      | \$629.00 |
|         |   | Grade 6 / Grade-in E                      | \$644.00 |
|         |   | Evita Leather (Black/White/Stone/Vanilla) | \$819.00 |
| AF478   | "Task" chair with independent back/seat angles (based on AF578)                                     | Grade 1 / COM                             | \$490.00 |
|         |   | Grade 2 / Grade-in A                      | \$505.00 |
|         |   | Grade 3 / Grade-in B                      | \$520.00 |
|         |   | Grade 4 / Grade-in C                      | \$535.00 |
|         |   | Grade 5 / Grade-in D                      | \$550.00 |
|         |   | Grade 6 / Grade-in E                      | \$565.00 |
|         |   | Evita Leather (Black/White/Stone/Vanilla) | \$740.00 |
| AF488   | "Multi-Function" chair with independent back / seat angles, forward / rocking tilt (based on AF588) | Grade 1 / COM                             | \$517.00 |
|         |   | Grade 2 / Grade-in A                      | \$532.00 |
|         |   | Grade 3 / Grade-in B                      | \$547.00 |
|         |   | Grade 4 / Grade-in C                      | \$562.00 |
|         |   | Grade 5 / Grade-in D                      | \$577.00 |
|         |   | Grade 6 / Grade-in E                      | \$592.00 |
|         |   | Evita Leather (Black/White/Stone/Vanilla) | \$767.00 |

## Description

- Fully upholstered and cushioned high-back
- Related modern, rectilinear contours of Affirm mesh backs
- Easy back height adjustment
- Small Affirm seat (default)

## Specifications

|                |                      |
|----------------|----------------------|
| Overall height | 38.5" - 46.25"       |
| Back           | 18.5 w x 21" h       |
| Seat           | 19" w x 17.5-20.6" d |
| COM            | 1 yd.                |

## features:

Begins @ \$171 armless / \$226 with BR-5 (BC42)

BC4x – smaller scale “student” chairs

BC8x – well-proportioned “budget management” chairs

BC9x – traditional design “budget executive” chairs

No-nonsense, practical design fits almost any budget

Long-lasting & proven contract quality “budget chairs”

→  
Use our  
handy  
stickers to  
mark this  
section.

bc series



**BC44**

Pictured here in optional Grade 1  
Elements Chlorine upholstery  
\$216.00 List (as shown)



**BC48**

Pictured here in optional Grade 1  
Elements Chlorine upholstery.  
\$245.00 List (as shown)



**BC46**

Pictured here in optional Grade 1  
Elements Chlorine upholstery.  
\$199.00 List (as shown)

# bc series

schools & education

Please see page 25 for relevant arm kit and cylinder options. See page 146 and 149 for other options.

budget series

| Model | Description            | Textile Grade-In     | List     | Specifications           |
|-------|------------------------|----------------------|----------|--------------------------|
| BC42  | Pneumatic lift         | Grade 1 / C.O.M.     | \$171.00 | Overall width 25"        |
|       | Pivot backrest         | Grade 2 / Grade-in A | \$186.00 | Overall height 33" - 41" |
|       | Back height adjustment | Grade 3 / Grade-in B | \$201.00 | Back 17" w x 15" h       |
|       | Back depth adjustment  | Grade 4 / Grade-in C | \$216.00 | Seat 18" w x 18" d       |
|       |                        | Grade 5 / Grade-in D | \$231.00 | Seat height 16" - 21"    |
|       |                        | Grade 6 / Grade-in E | \$246.00 | COM 1 yard               |
|       |                        |                      |          | Carton weight 30 pounds  |
|       |                        |                      |          | UPS weight 36 pounds     |
|       |                        |                      |          | Arms Group BC            |
|       |                        |                      |          | Warranty 7 year limited  |



| Model | Description            | Textile Grade-In     | List     | Specifications           |
|-------|------------------------|----------------------|----------|--------------------------|
| BC44  | Pneumatic lift         | Grade 1 / C.O.M.     | \$216.00 | Overall width 25"        |
|       | Pivot backrest         | Grade 2 / Grade-in A | \$231.00 | Overall height 33" - 41" |
|       | Back height adjustment | Grade 3 / Grade-in B | \$246.00 | Back 17" w x 15" h       |
|       | Tilting backrest       | Grade 4 / Grade-in C | \$261.00 | Seat 18" w x 18" d       |
|       | Tilting seat           | Grade 5 / Grade-in D | \$276.00 | Seat height 16" - 21"    |
|       |                        | Grade 6 / Grade-in E | \$291.00 | COM 1 yard               |
|       |                        |                      |          | Carton weight 34 pounds  |
|       |                        |                      |          | UPS weight 36 pounds     |
|       |                        |                      |          | Arms Group BC            |
|       |                        |                      |          | Warranty 7 year limited  |



| Model | Description            | Textile Grade-In     | List     | Specifications           |
|-------|------------------------|----------------------|----------|--------------------------|
| BC46  | Pneumatic lift         | Grade 1 / C.O.M.     | \$199.00 | Overall width 25"        |
|       | Pivot backrest         | Grade 2 / Grade-in A | \$214.00 | Overall height 35" - 43" |
|       | Back height adjustment | Grade 3 / Grade-in B | \$229.00 | Back 19" w x 17.5" h     |
|       | Back depth adjustment  | Grade 4 / Grade-in C | \$244.00 | Seat 19" w x 19" d       |
|       |                        | Grade 5 / Grade-in D | \$259.00 | Seat height 16" - 21"    |
|       |                        | Grade 6 / Grade-in E | \$274.00 | COM 1 yard               |
|       |                        |                      |          | Carton weight 35 pounds  |
|       |                        |                      |          | UPS weight 36 pounds     |
|       |                        |                      |          | Arms Group BC            |
|       |                        |                      |          | Warranty 7 year limited  |



| Model | Description            | Textile Grade-In     | List     | Specifications           |
|-------|------------------------|----------------------|----------|--------------------------|
| BC48  | Pneumatic lift         | Grade 1 / C.O.M.     | \$245.00 | Overall width 25"        |
|       | Pivot backrest         | Grade 2 / Grade-in A | \$260.00 | Overall height 35" - 43" |
|       | Back height adjustment | Grade 3 / Grade-in B | \$275.00 | Back 19" w x 17.5" h     |
|       | Tilting backrest       | Grade 4 / Grade-in C | \$290.00 | Seat 19" w x 19" d       |
|       | Tilting seat           | Grade 5 / Grade-in D | \$305.00 | Seat height 16" - 21"    |
|       |                        | Grade 6 / Grade-in E | \$320.00 | COM 1 yard               |
|       |                        |                      |          | Carton weight 40 pounds  |
|       |                        |                      |          | UPS weight 42 pounds     |
|       |                        |                      |          | Arms Group BC            |
|       |                        |                      |          | Warranty 7 year limited  |



Note: Most BC chairs ship partially assembled when boxed.

Please see page 25 for relevant arm kit and cylinder options. See page 146 and 149 for other options.

budget management

**Model**

BC85



**Description**

Pneumatic lift  
Synchronous seat/back tilt  
Tilt lock at upright only  
Tension knob

**Textile Grade-In**

Grade 1 / C.O.M. \$258.00  
Grade 2 / Grade-in A \$273.00  
Grade 3 / Grade-in B \$288.00  
Grade 4 / Grade-in C \$303.00  
Grade 5 / Grade-in D \$318.00  
Grade 6 / Grade-in E \$333.00

**List**

**Specifications**

Overall width 25"  
Overall height 38" - 43"  
Back 18.5" w x 19" h  
Seat 20" w x 20" d  
Seat height 16" - 20"  
COM 1 yard  
Carton weight 40 pounds  
UPS weight 68 pounds  
Arms Group BC  
Warranty 7 year limited

**Model**

BC86



**Description**

Pneumatic lift  
Swivel/rocking tilt  
Tilt lock at upright only  
Tension knob  
Fixed loop arms standard

**Textile Grade-In**

Grade 1 / C.O.M. \$308.00  
Grade 2 / Grade-in A \$323.00  
Grade 3 / Grade-in B \$338.00  
Grade 4 / Grade-in C \$353.00  
Grade 5 / Grade-in D \$368.00  
Grade 6 / Grade-in E \$383.00

**List**

**Specifications**

Overall width 26"  
Overall height 38" - 42"  
Back 19" w x 22" h  
Seat 20" w x 20" d  
Seat height 16" - 20"  
COM 1.5 yards  
Carton weight 48 pounds  
UPS weight 101 pounds  
Arms Included  
Warranty 7 year limited

**Model**

BC87



**Description**

Pneumatic lift  
Swivel/rocking tilt  
Tilt lock at upright only  
Tension knob  
Fixed loop arms standard

**Textile Grade-In**

Grade 1 / C.O.M. \$351.00  
Grade 2 / Grade-in A \$366.00  
Grade 3 / Grade-in B \$381.00  
Grade 4 / Grade-in C \$396.00  
Grade 5 / Grade-in D \$411.00  
Grade 6 / Grade-in E \$426.00

**List**

**Specifications**

Overall width 26"  
Overall height 44" - 48"  
Back 19" w x 26" h  
Seat 20" w x 20" d  
Seat height 16" - 20"  
COM 1.5 yards  
Carton weight 54 pounds  
UPS weight 101 pounds  
Arms Included  
Warranty 7 year limited

Note: Most BC chairs ship partially assembled when boxed.

# bc series

schools & education

Please see page 25 for relevant arm kit and cylinder options. See page 146 and 149 for other options.

budget executive

| Model  | Description               | Textile Grade-In | List     | Specifications                        |
|--|---------------------------|------------------|----------|---------------------------------------|
| <b>BC98</b><br> | Pneumatic lift            | Black leather    | \$439.00 | Overall width 26"                     |
|  | Simple knee tilt          |                  |          | Overall height 43" - 46"              |
|  | Tilt lock at upright only |                  |          | Back 20" w x 24" h                    |
|  | Tension knob              |                  |          | Seat 21" w x 20" d                    |
|  | Fixed loop arms standard  |                  |          | Seat height 18" - 21"                 |
|  |                           |                  |          | COM N/A                               |
|  |                           |                  |          | Carton weight 42 (box 1) / 31 (box 2) |
|  |                           |                  |          | UPS weight 42 (box 1) / 36 (box 2)    |
|  |                           |                  |          | Arms Included                         |
|  |                           |                  |          | Warranty 7 year limited               |

| Model  | Description               | Textile Grade-In | List     | Specifications                        |
|--|---------------------------|------------------|----------|---------------------------------------|
| <b>BC99</b><br> | Pneumatic lift            | Black leather    | \$487.00 | Overall width 26"                     |
|  | Simple knee tilt          |                  |          | Overall height 47" - 50"              |
|  | Tilt lock at upright only |                  |          | Back 20" w x 28" h                    |
|  | Tension knob              |                  |          | Seat 21" w x 20" d                    |
|  | Fixed loop arms standard  |                  |          | Seat height 18" - 21"                 |
|  |                           |                  |          | COM N/A                               |
|  |                           |                  |          | Carton weight 42 (box 1) / 32 (box 2) |
|  |                           |                  |          | UPS weight 42 (box 1) / 39 (box 2)    |
|  |                           |                  |          | Arms Included                         |
|  |                           |                  |          | Warranty 7 year limited               |

BC98 and BC99 notes: Ships K.D. in 2 boxes per 1 chair. Backrest may contain discrete but visible pilot holes in bottom corners.

Please see page 25 for relevant arm kit and cylinder options. See page 146 and 149 for other options.

budget stools

| Model | Description            | Textile Grade-In     | List     | Specifications           |
|-------|------------------------|----------------------|----------|--------------------------|
| BC41  | Pneumatic lift         | Grade 1 / C.O.M.     | \$219.00 | Overall width 25"        |
|       | Pivot backrest         | Grade 2 / Grade-in A | \$234.00 | Overall height 40" - 52" |
|       | Back height adjustment | Grade 3 / Grade-in B | \$249.00 | Back 17" w x 15" h       |
|       | Back depth adjustment  | Grade 4 / Grade-in C | \$264.00 | Seat 18" w x 18" d       |
|       | 18" chrome footring    | Grade 5 / Grade-in D | \$279.00 | Seat height 23" - 33"    |
|       |                        | Grade 6 / Grade-in E | \$294.00 | COM 1 yard               |
|       |                        |                      |          | Carton weight 34 pounds  |
|       |                        |                      |          | UPS weight 36 pounds     |
|       |                        |                      |          | Arms Group BC            |
|       |                        |                      |          | Warranty 7 year limited  |



| Model | Description            | Textile Grade-In     | List     | Specifications           |
|-------|------------------------|----------------------|----------|--------------------------|
| BC45  | Pneumatic lift         | Grade 1 / C.O.M.     | \$257.00 | Overall width 26"        |
|       | Pivot backrest         | Grade 2 / Grade-in A | \$272.00 | Overall height 40" - 52" |
|       | Back height adjustment | Grade 3 / Grade-in B | \$287.00 | Back 17" w x 15" h       |
|       | Tilting backrest       | Grade 4 / Grade-in C | \$302.00 | Seat 18" w x 18" d       |
|       | Tilting seat           | Grade 5 / Grade-in D | \$317.00 | Seat height 23" - 33"    |
|       | 18" chrome footring    | Grade 6 / Grade-in E | \$332.00 | COM 1 yard               |
|       |                        |                      |          | Carton weight 38 pounds  |
|       |                        |                      |          | UPS weight 38 pounds     |
|       |                        |                      |          | Arms Group BC            |
|       |                        |                      |          | Warranty 7 year limited  |



| Model | Description              | Textile Grade-In     | List     | Specifications           |
|-------|--------------------------|----------------------|----------|--------------------------|
| BC47  | Pneumatic lift           | Grade 1 / C.O.M.     | \$248.00 | Overall width 26"        |
|       | Pivot backrest           | Grade 2 / Grade-in A | \$263.00 | Overall height 42" - 55" |
|       | Back height adjustment   | Grade 3 / Grade-in B | \$278.00 | Back 19" w x 17.5" h     |
|       | Back depth adjustment    | Grade 4 / Grade-in C | \$293.00 | Seat 19" w x 19" d       |
|       | 20" black nylon footring | Grade 5 / Grade-in D | \$308.00 | Seat height 23" - 33"    |
|       |                          | Grade 6 / Grade-in E | \$323.00 | COM 1 yard               |
|       |                          |                      |          | Carton weight 39 pounds  |
|       |                          |                      |          | UPS weight 44 pounds     |
|       |                          |                      |          | Arms Group BC            |
|       |                          |                      |          | Warranty 7 year limited  |



| Model | Description            | Textile Grade-In     | List     | Specifications           |
|-------|------------------------|----------------------|----------|--------------------------|
| BC49  | Pneumatic lift         | Grade 1 / C.O.M.     | \$287.00 | Overall width 26"        |
|       | Pivot backrest         | Grade 2 / Grade-in A | \$302.00 | Overall height 42" - 55" |
|       | Back height adjustment | Grade 3 / Grade-in B | \$317.00 | Back 19" w x 17.5" h     |
|       | Tilting seat           | Grade 4 / Grade-in C | \$332.00 | Seat 19" w x 19" d       |
|       | Tilting back           | Grade 5 / Grade-in D | \$347.00 | Seat height 23" - 33"    |
|       | 20" chrome footring    | Grade 6 / Grade-in E | \$362.00 | COM 1 yard               |
|       |                        |                      |          | Carton weight 46 pounds  |
|       |                        |                      |          | UPS weight 68 pounds     |
|       |                        |                      |          | Arms Group BC            |
|       |                        |                      |          | Warranty 7 year limited  |



Budget leather executive series may have visible pilot holes in a discreet corner of backrest.

Above weights do not include optional arm kits. ; UPS weight is calculated using UPS dimensional standards to determine billable weight. ; Pricing and specifications subject to change without notification.

# bc series

schools & education

Please see page 149 for upholstery options to BC48S.

budget side chairs

| Model | Description | Textile Grade-In        | List     | Specifications           |
|-------|-------------|-------------------------|----------|--------------------------|
| BC48S | Sled base   | Grade 1 / C.O.M.        | \$178.00 | Overall width 20"        |
|       |             | Grade 2 / Grade-in A    | \$193.00 | Overall height 37" - 39" |
|       |             | Grade 3 / Grade-in B    | \$208.00 | Back 19" w x 17.5" h     |
|       |             | Grade 4 / Grade-in C    | \$223.00 | Seat 19" w x 19" d       |
|       |             | Grade 5 / Grade-in D    | \$238.00 | Seat height 18"          |
|       |             | Grade 6 / Grade-in E    | \$253.00 | COM 1 yard               |
|       |             |                         |          | Carton weight 36 pounds  |
|       |             | UPS weight 68 pounds    |          |                          |
|       |             | Arms Group BC           |          |                          |
|       |             | Warranty 7 year limited |          |                          |



| Model | Description                           | Textile Grade-In        | List     | Specifications          |
|-------|---------------------------------------|-------------------------|----------|-------------------------|
| BC86S | Sled base<br>Fixed loop arms standard | Grade 1 / C.O.M.        | \$245.00 | Overall width 25"       |
|       |                                       | Grade 2 / Grade-in A    | \$260.00 | Overall height 37.5"    |
|       |                                       | Grade 3 / Grade-in B    | \$275.00 | Back 19" w x 22" h      |
|       |                                       | Grade 4 / Grade-in C    | \$290.00 | Seat 20" w x 20" d      |
|       |                                       | Grade 5 / Grade-in D    | \$305.00 | Seat height 18"         |
|       |                                       | Grade 6 / Grade-in E    | \$320.00 | COM 1.5 yards           |
|       |                                       |                         |          | Carton weight 40 pounds |
|       |                                       | UPS weight 101 pounds   |          |                         |
|       |                                       | Arms Included           |          |                         |
|       |                                       | Warranty 7 year limited |          |                         |



| Model | Description              | Textile Grade-In | List     | Specifications          |
|-------|--------------------------|------------------|----------|-------------------------|
| BC98S | Sled base                | Black leather    | \$358.00 | Overall width 26"       |
|       | Fixed loop arms standard |                  |          | Overall height 42"      |
|       |                          |                  |          | Back 20" w x 24" h      |
|       |                          |                  |          | Seat 21" w x 20" d      |
|       |                          |                  |          | Seat height 18"         |
|       |                          |                  |          | COM N/A                 |
|       |                          |                  |          | Carton weight 67 pounds |
|       |                          |                  |          | UPS weight 70 pounds    |
|       |                          |                  |          | Arms Included           |
|       |                          |                  |          | Warranty 7 year limited |







BC98S note: Ships K.D. in 2 boxed. Backrest may contain discrete but visible pilot holes in bottom corners.

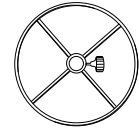

common options

**Common Options for BC Series**

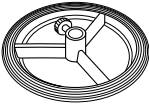
|   |  |   |  |
|---|--|---|--|
| <b>Arms kits</b>  | <p><b>BR-2</b> - list: 46.00<br/>Width adjustable loop arms<br/>Adjustable with range of 2.5"<br/>7 year limited warranty*</p>   |  | <p><b>BR-85</b> - list: 40.00<br/>Fixed loop arms<br/>Fits BC85 chair<br/>7 year limited warranty</p>  |
|    | <p><b>BR-5</b> - list: 55.00<br/>Height &amp; width adjustable T-arms<br/>Adjustable height range of 2.5"<br/>Adjustable width range of 2.5"<br/>7 year limited warranty*<br/>Note: Version for BC85 is available upon request</p> |   |  |
| <b>Options</b>  | <p><b>FTGBC41</b> - list: 16.00 (upcharge), 59.00 (buy)<br/>18" chrome footring for BC, CL and WS<br/>(or exchange with black plastic footring)</p>  |  | <p><b>CYL-4M</b> - list: 13.00 (upcharge), 88.00 (buy)<br/>4" cylinder for BC chairs (minimum height lowered by 1", changes range to 4")</p> |
|    | <p><b>FTG20PL</b> - list: 16.00 (upcharge), 59.00 (buy)<br/>20" black plastic footring for BC and WS<br/>(or exchange with chrome footring)</p>  |   | <p><b>CYL-5M</b> - list: 13.00 (upcharge), 73.00 (buy)<br/>5" cylinder for most of BC task and executive chairs</p>                          |
|  | <p><b>TLTRAY</b> - list: N/A (upcharge), 43.00 (buy)<br/>Tool tray fits WS Series workstools and other chairs (check with OM for compatibility)</p>  |   | <p><b>CYL-10M</b> - list: N/A (upcharge), 102.00 (buy)<br/>10" cylinder: standard cylinder for BC drafting stools (range of 23-33")</p>      |



## features:

Begins @ \$722 with polished aluminum loop arms (CE88)

We kept it simple & the series name says it all about the CE's uses!

"Body-Activated Motion" responds to user's weight without cumbersome tension knob

Contemporary pillow-top design with black, full-grain leather seat/back surfaces



**CE88**

Pictured here with standard polished aluminum arms, and upholstered in top-grain black leather \$722.00 List (as shown)



**CE89**

Pictured here with standard polished aluminum arms, headrest and upholstered in top-grain black leather \$774.00 List (as shown)

→  
Use our  
handy  
stickers to  
mark this  
section.

conference  
executive series  
(CE)

# conference executive series (CE)

conference  
boardroom  
executive

Please see page 146 for caster options.

conference executive

| Model | Description   | Textile Grade-In                        | List     | Specifications   |
|-------|---|---|----------|--|
| CE88  | Full-grain leather seat & backrest<br>Self-weighing<br>(tension adjustment free)<br>Pillow top backrest/seat<br>Pneumatic lift<br>Fixed, polished aluminum loop arms<br>Polished aluminum base<br>Adjustable lumbar<br>Dual-tone oversized soft casters | Full-grain leather seat<br>and backrest | \$722.00 | Overall width 27"<br>Overall height 39" - 44"<br>Back 18.25" w x 22.5" h<br>Seat 19.25" w x 19" d<br>Seat height 16.5" - 21.5"<br>COM N/A<br>Carton weight 50 pounds<br>UPS weight 101 pounds<br>Arms Included<br>Warranty 12 year limited |



300  
POUNDS  
CAPACITY

| Model | Description   | Textile Grade-In                        | List     | Specifications   |
|-------|---|---|----------|--|
| CE89  | Full-grain leather seat & backrest<br>Self-weighing<br>(tension adjustment free)<br>Pillow top backrest/seat<br>Pneumatic lift<br>Fixed, polished aluminum loop arms<br>Polished aluminum base<br>Adjustable lumbar<br>Dual-tone oversized soft casters<br><b>Adjustable leather headrest</b> | Full-grain leather seat<br>and backrest | \$774.00 | Overall width 27"<br>Overall height 47" - 52"<br>Back 18.25" w x 30.5" h<br>Seat 19.25" w x 19" d<br>Seat height 16.5" - 21.5"<br>COM N/A<br>Carton weight 52 pounds<br>UPS weight 101 pounds<br>Arms Included<br>Warranty 12 year limited |



300  
POUNDS  
CAPACITY

## features:

Begins @ \$176 armless stool (CL12)

CL1x, -2x, -3x – Thoughtfully designed for doctor's exam rooms

- Casters that move less readily until a user is fully seated
- 360 degree accessible, round exam stool height adjuster
- Foot-activated seat height control for hygienic adjustments
- Priced to keep your patients AND wallets both happy and healthy!

CL4x – Modestly priced simple task stools and chairs with basic features



**CL15**

Pictured here grade 3  
Stage Fame upholstery  
\$509.00 List (as shown)



**CL12**

Pictured here grade 3  
Symphony Trumpet upholstery  
\$206.00 List (as shown)



**CL35**

Pictured here grade 3  
Symphony Trumpet upholstery  
\$322.00 List (as shown)

→  
Use our  
handy  
stickers to  
mark this  
section.

classic  
professional  
series (CL)

# classic professional series (CL)

healthcare | lab

Please see pages 33, 146 -149 for casters and options.

exam room stools

| Model | Description                 | Textile Grade-In     | List     | Specifications             |
|-------|-----------------------------|----------------------|----------|----------------------------|
| CL12  | Pneumatic lift              | Grade 1 / C.O.M.     | \$176.00 | Overall width 22"          |
|       | Chrome base                 | Grade 2 / Grade-in A | \$191.00 | Overall height 15.5" - 20" |
|       | Safety soft casters         | Grade 3 / Grade-in B | \$206.00 | Back N/A                   |
|       | Circle ring height adjuster | Grade 4 / Grade-in C | \$221.00 | Seat 16" diameter          |
|       |                             | Grade 5 / Grade-in D | \$236.00 | Seat height 15.5" - 20"    |
|       |                             | Grade 6 / Grade-in E | \$251.00 | COM .75 yd.                |
|       |                             |                      |          | Carton weight 23 pounds    |
|       |                             |                      |          | UPS weight 28 pounds       |
|       |                             |                      |          | Arms N/A                   |
|       |                             |                      |          | Warranty 12 year limited   |



| Model | Description                                     | Textile Grade-In     | List     | Specifications           |
|-------|---|----------------------|----------|--------------------------|
| CL13  | Pneumatic lift                                  | Grade 1 / C.O.M.     | \$258.00 | Overall width 22"        |
|       | Chrome base                                     | Grade 2 / Grade-in A | \$273.00 | Overall height 22" - 32" |
|       | Safety soft casters                             | Grade 3 / Grade-in B | \$288.00 | Back N/A                 |
|       | Circle ring height adjuster                     | Grade 4 / Grade-in C | \$303.00 | Seat 16" diameter        |
|       | 18" chrome footring                             | Grade 5 / Grade-in D | \$318.00 | Seat height 22" - 32"    |
|       | Optional 8" cylinder available<br>18.5" - 26.5" | Grade 6 / Grade-in E | \$333.00 | COM .75 yd.              |
|       |   |                      |          | Carton weight 23 pounds  |
|       |   |                      |          | UPS weight 28 pounds     |
|       |   |                      |          | Arms N/A                 |
|       |   |                      |          | Warranty 12 year limited |



| Model | Description         | Textile Grade-In     | List     | Specifications           |
|-------|---------------------|----------------------|----------|--------------------------|
| CL14  | Pneumatic lift      | Grade 1 / C.O.M.     | \$361.00 | Overall width 22"        |
|       | Chrome base         | Grade 2 / Grade-in A | \$376.00 | Overall height 16" - 21" |
|       | Safety soft casters | Grade 3 / Grade-in B | \$391.00 | Back N/A                 |
|       | Foot activation     | Grade 4 / Grade-in C | \$406.00 | Seat 16" diameter        |
|       |                     | Grade 5 / Grade-in D | \$421.00 | Seat height 16" - 21"    |
|       |                     | Grade 6 / Grade-in E | \$436.00 | COM .75 yd.              |
|       |                     |                      |          | Carton weight 25 pounds  |
|       |                     |                      |          | UPS weight 28 pounds     |
|       |                     |                      |          | Arms N/A                 |
|       |                     |                      |          | Warranty 12 year limited |



| Model | Description            | Textile Grade-In     | List     | Specifications           |
|-------|------------------------|----------------------|----------|--------------------------|
| CL15  | Pneumatic lift         | Grade 1 / C.O.M.     | \$479.00 | Overall width 25"        |
|       | Chrome base            | Grade 2 / Grade-in A | \$494.00 | Overall height 28" - 36" |
|       | Safety soft casters    | Grade 3 / Grade-in B | \$509.00 | Back 13" w x 11" h       |
|       | Foot activation        | Grade 4 / Grade-in C | \$524.00 | Seat 16" diameter        |
|       | Back height adjustment | Grade 5 / Grade-in D | \$539.00 | Seat height 16" - 21"    |
|       | Fabric panel back      | Grade 6 / Grade-in E | \$554.00 | COM 1 yd.                |
|       | Unique back support    |                      |          | Carton weight 30 pounds  |
|       |                        |                      |          | UPS weight 33 pounds     |
|       |                        |                      |          | Arms N/A                 |
|       |                        |                      |          | Warranty 12 year limited |



omsmartseating.com

SMART SEATING





Please see pages 33, 146 -149 for casters and options.

exam room stools

| Model   | Description            | Textile Grade-In     | List                     | Specifications           |
|---|------------------------|----------------------|--------------------------|--------------------------|
| CL22<br> | Pneumatic lift         | Grade 1 / C.O.M.     | \$283.00                 | Overall width 25"        |
|   | Chrome base            | Grade 2 / Grade-in A | \$298.00                 | Overall height 28" - 37" |
|   | Safety soft casters    | Grade 3 / Grade-in B | \$313.00                 | Back 13" w x 11" h       |
|   | Paddle height adjuster | Grade 4 / Grade-in C | \$328.00                 | Seat 16" diameter        |
|   | Back height adjustment | Grade 5 / Grade-in D | \$343.00                 | Seat height 16" - 21"    |
|   | Fabric panel back      | Grade 6 / Grade-in E | \$358.00                 | COM 1 yd.                |
|   | Unique back support    |                      |                          | Carton weight 31 pounds  |
|   |                        |                      | UPS weight 33 pounds     |                          |
|   |                        |                      | Arms N/A                 |                          |
|   |                        |                      | Warranty 12 year limited |                          |

| Model   | Description            | Textile Grade-In     | List                     | Specifications           |
|---|------------------------|----------------------|--------------------------|--------------------------|
| CL23<br> | Pneumatic lift         | Grade 1 / C.O.M.     | \$364.00                 | Overall width 25"        |
|   | Chrome base            | Grade 2 / Grade-in A | \$379.00                 | Overall height 35" - 47" |
|   | Safety soft casters    | Grade 3 / Grade-in B | \$394.00                 | Back 13" w x 11" h       |
|   | Paddle height adjuster | Grade 4 / Grade-in C | \$409.00                 | Seat 16" diameter        |
|   | 18" chrome footring    | Grade 5 / Grade-in D | \$424.00                 | Seat height 23" - 33"    |
|   | Back height adjustment | Grade 6 / Grade-in E | \$439.00                 | COM 1 yd.                |
|   | Fabric panel back      |                      |                          | Carton weight 31 pounds  |
| Unique back support   |                        |                      | UPS weight 33 pounds     |                          |
| Optional 8" cylinder available<br>20" - 28"   |                        |                      | Arms N/A                 |                          |
|   |                        |                      | Warranty 12 year limited |                          |

| Model   | Description                 | Textile Grade-In     | List                     | Specifications           |
|---|-----------------------------|----------------------|--------------------------|--------------------------|
| CL33<br> | Pneumatic lift              | Grade 1 / C.O.M.     | \$242.00                 | Overall width 27"        |
|   | Chrome elevated base        | Grade 2 / Grade-in A | \$257.00                 | Overall height 25" - 33" |
|   | Safety soft casters         | Grade 3 / Grade-in B | \$272.00                 | Back N/A                 |
|   | Circle ring height adjuster | Grade 4 / Grade-in C | \$287.00                 | Seat 16" diameter        |
|   | 8" chrome cylinder          | Grade 5 / Grade-in D | \$302.00                 | Seat height 25" - 33"    |
|   |                             | Grade 6 / Grade-in E | \$317.00                 | COM .75 yd.              |
|   |                             |                      |                          | Carton weight 26 pounds  |
|   |                             |                      | UPS weight 33 pounds     |                          |
|   |                             |                      | Arms N/A                 |                          |
|   |                             |                      | Warranty 12 year limited |                          |

| Model   | Description            | Textile Grade-In     | List                     | Specifications           |
|---|------------------------|----------------------|--------------------------|--------------------------|
| CL35<br> | Pneumatic lift         | Grade 1 / C.O.M.     | \$292.00                 | Overall width 27"        |
|   | Chrome elevated base   | Grade 2 / Grade-in A | \$307.00                 | Overall height 37" - 47" |
|   | Safety soft casters    | Grade 3 / Grade-in B | \$322.00                 | Back 13" w x 11" h       |
|   | Back height adjustment | Grade 4 / Grade-in C | \$337.00                 | Seat 16" diameter        |
|   | Fabric panel back      | Grade 5 / Grade-in D | \$352.00                 | Seat height 25" - 33"    |
|   | Unique back support    | Grade 6 / Grade-in E | \$367.00                 | COM 1 yd.                |
|   |                        |                      |                          | Carton weight 29 pounds  |
|   |                        |                      | UPS weight 33 pounds     |                          |
|   |                        |                      | Arms N/A                 |                          |
|   |                        |                      | Warranty 12 year limited |                          |

# classic professional series (CL)

healthcare | lab

Please see pages 33, 138 -149 for arm kits, casters, and other options.

small / petite

| Model  | Description                                | Textile Grade-In                          | List                     | Specifications           |
|--------|--|---|--------------------------|--------------------------|
| CL44EZ | Pneumatic lift                             | Grade 1 / C.O.M.                          | \$304.00                 | Overall width 25"        |
|        | EZ Back height adjustment                  | Grade 2 / Grade-in A                      | \$319.00                 | Overall height 32" - 41" |
|        | Pivot backrest                             | Grade 3 / Grade-in B                      | \$334.00                 | Back 16" w x 13" h       |
|        | Independent seat and back angle adjustment | Grade 4 / Grade-in C                      | \$349.00                 | Seat 18" w x 17" d       |
|        |  | Grade 5 / Grade-in D                      | \$364.00                 | Seat height 16" - 21"    |
|        |  | Grade 6 / Grade-in E                      | \$379.00                 | COM 1 yd.                |
|        |  | Evita leather (Black/White/Stone/Vanilla) | \$529.00                 | Carton weight 33 pounds  |
|        |  |   | UPS weight 68 pounds     |                          |
|        |  |   | Arms Group 1 & 4         |                          |
|        |  |   | Warranty 12 year limited |                          |



| Model  | Description  | Textile Grade-In     | List                     | Specifications           |
|--------|--|----------------------|--------------------------|--------------------------|
| CL44MD | Pneumatic lift                                     | Grade 1 / C.O.M.     | \$292.00                 | Overall width 25"        |
|        | EZ Back height adjustment                          | Grade 2 / Grade-in A | \$307.00                 | Overall height 32" - 41" |
|        | Infinitely locking back tilt                       | Grade 3 / Grade-in B | \$322.00                 | Back 16" w x 13" h       |
|        | Polished aluminum package                          | Grade 4 / Grade-in C | \$337.00                 | Seat 18" w x 17" d       |
|        | Glides (carpet casters available with no upcharge) | Grade 5 / Grade-in D | \$352.00                 | Seat height 16" - 21"    |
|        |  | Grade 6 / Grade-in E | \$367.00                 | COM 1 yd.                |
|        |  |                      |                          | Carton weight 34 pounds  |
|        |  |                      | UPS weight 68 pounds     |                          |
|        |  |                      | Arms Group 1 & 4         |                          |
|        |  |                      | Warranty 12 year limited |                          |



average / medium

| Model  | Description                                | Textile Grade-In                          | List                     | Specifications             |
|--------|--|---|--------------------------|----------------------------|
| CL48EZ | Pneumatic lift                             | Grade 1 / C.O.M.                          | \$350.00                 | Overall width 25"          |
|        | EZ Back height adjustment                  | Grade 2 / Grade-in A                      | \$365.00                 | Overall height 37" - 45.5" |
|        | Pivot backrest                             | Grade 3 / Grade-in B                      | \$380.00                 | Back 17" w x 22" h         |
|        | Independent seat and back angle adjustment | Grade 4 / Grade-in C                      | \$395.00                 | Seat 18" w x 17" d         |
|        |  | Grade 5 / Grade-in D                      | \$410.00                 | Seat height 16" - 21"      |
|        |  | Grade 6 / Grade-in E                      | \$425.00                 | COM 1 yard                 |
|        |  | Evita leather (Black/White/Stone/Vanilla) | \$575.00                 | Carton weight 39 pounds    |
|        |  |   | UPS weight 101 pounds    |                            |
|        |  |   | Arms Group 1 & 4         |                            |
|        |  |   | Warranty 12 year limited |                            |





Please see pages 138 - 149 for arm kits, casters, and other options.

stools

| Model  | Description                                | Textile Grade-In            | List     | Specifications           |
|--|--|-----------------------------|----------|--------------------------|
| <br><b>CL45EZ</b> | Pneumatic lift                             | Grade 1 / C.O.M.            | \$395.00 | Overall width 27"        |
|  | EZ Back height adjustment                  | Grade 2 / Grade-in A        | \$410.00 | Overall height 41" - 55" |
|  | Pivot backrest                             | Grade 3 / Grade-in B        | \$425.00 | Back 16" w x 13" h       |
|  | 20" chrome footring                        | Grade 4 / Grade-in C        | \$440.00 | Seat 18" w x 17" d       |
|  | Independent seat and back angle adjustment | Grade 5 / Grade-in D        | \$455.00 | Seat height 24" - 34"    |
|  |  | Grade 6 / Grade-in E        | \$470.00 | COM 1 yard               |
|  |  | Evita leather               |          | Carton weight 39 pounds  |
|  |  | (Black/White/Stone/Vanilla) | \$620.00 | UPS weight 68 pounds     |
|  | Optional 8" cylinder available (20" - 28") |                             |          | Arms Group 1 & 4         |
|  |  |                             |          | Warranty 12 year limited |



| Model  | Description                  | Textile Grade-In            | List     | Specifications            |
|--|------------------------------|-----------------------------|----------|---------------------------|
| <br><b>CL47</b> | Pneumatic lift               | Grade 1 / C.O.M.            | \$479.00 | Overall width 27"         |
|  | EZ Back height adjustment    | Grade 2 / Grade-in A        | \$494.00 | Overall height 41" - 54"  |
|  | Infinitely locking back tilt | Grade 3 / Grade-in B        | \$509.00 | Back 17" w x 16.5" h      |
|  | Seat slider                  | Grade 4 / Grade-in C        | \$524.00 | Seat 20" w x 17-20.1" d   |
|  | Turn-lock footring           | Grade 5 / Grade-in D        | \$539.00 | Seat height 25.5" - 35.5" |
|  |                              | Grade 6 / Grade-in E        | \$554.00 | COM 1 yard                |
|  |                              | Evita leather               |          | Carton weight 58 pounds   |
|  |                              | (Black/White/Stone/Vanilla) | \$704.00 | UPS weight 101 pounds     |
|  |                              |                             |          | Arms Group 1 & 4          |
|  |                              |                             |          | Warranty 12 year limited  |

common options

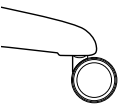
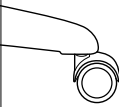
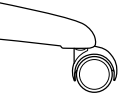
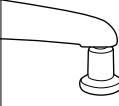
**Suggested Options for CL Series**

| Casters   |  |   |   |
|---|--|---|---|
|  | <b>CAS0065-S</b> - list: 25.00 (upcharge)<br>Multi-Surface Soft Caster<br>Dual-colored; designed for wood, tile and smooth or harder surfaces. For most stools.<br>(5 per set) |  | <b>CAS0050-RB</b> - list: 35.00 (upcharge)<br>Reverse Braking Caster<br>Restricted chair movement when chair IS in use<br>(5 per set) |
|  | <b>CAS0050-SS</b> - list: 25.00 (upcharge)<br>Safety Soft Caster<br>Minimizes chair movement when NOT in use<br>(5 per set)  |  | <b>GLD</b> - (no charge to substitute)<br>Not appropriate for all models. Check with factory for details (5 per set)                  |

**Suggested Options for CL Series (CL44EZ, CL44MD, CL45EZ & CL48EZ)**

| Arms kits   |  |   |  |
|---|--|---|--|
|  | <b>KR240M</b> - list: 134.00<br>Lowest height and width adjustable and removable T-arms with natural grip control<br>Memosoft arm pads included<br>Adjustable height range of 2.75"<br>Adjustable width range of approx. 1.25" per side<br>12 year limited warranty on arm frames &<br>2 year limited warranty on arm pads |  | <b>KR445</b> - list: 175.00<br>Height and width adjustable T-arms with smooth fore-aft, side-to-side, and pivoting motion arm caps<br>Adjustable width range of approximately 1.25" per side<br>12 year limited warranty on arm frames &<br>2 year limited warranty on arm pads* |
|  | <b>KR200</b> - list: 109.00<br>Height and width adjustable and removable T-arms with natural grip control<br>Adjustable height range of 2.75"<br>Adjustable width range of approx. 1.25" per side<br>12 year limited warranty on arm frames &<br>2 year limited warranty on arm pads                                       |   |  |

See pages 138 to 149 for a complete listing of all available arm, cylinder, caster, and other ergonomic options. Not all options may be applicable to a given model. Check with OM for compatibility details.

Above weights do not include optional arm kits. ; UPS weight is calculated using UPS dimensional standards to determine billable weight. ; Pricing and specifications subject to change without notification.



## features:

Begins @ \$417 armless / \$526 with KR-200 arms (CLS53)

"No fuss" & durable lab stools were designed with ease-of-access in mind

Lab Stool counterparts to the PA53, PA55 and PA57D

(i.e., CLS53, CLS61, CLS57D, respectively)

Fixed height, welded-on, extra-wide footring allows for stable foot support



**CLS53**

Pictured here with optional KR-240M arms and Grade 1 Elements Carbon upholstery  
\$551.00 List (as shown)



**CLS61**

Pictured here with optional JR-39 arms and Grade 1 Elements Carbon upholstery  
\$596.00 List (as shown)



**CLS57D**

Pictured here with optional KR-251M arms and Grade 1 Spice Nutmeg upholstery  
\$633.00 List (as shown)

→  
Use our  
handy  
stickers to  
mark this  
section.  
classic lab  
stools (CLS)

# classic lab stools (CLS)

healthcare & lab

Please see pages 138 -149 for arm kits, casters, and other options.

small / petite

| Model | Description                       | Textile Grade-In                             | List     | Specifications   |
|-------|-----------------------------------|--|----------|--|
| CLS53 | Pneumatic lift                    | Grade 1 / C.O.M.                             | \$417.00 | Overall width 27"  |
|       | Tilting backrest                  | Grade 2 / Grade-in A                         | \$437.00 | Overall height 43" - 54"   |
|       | EZ back height adjustment         | Grade 3 / Grade-in B                         | \$457.00 | Back 17" w x 16.5" h   |
|       | Seat depth adjustment             | Grade 4 / Grade-in C                         | \$477.00 | Seat 19" w x 16.5-19.6" d  |
|       | Grande Spider Package             | Grade 5 / Grade-in D                         | \$497.00 | Seat height 25" - 33"  |
|       | Dual-toned oversized soft casters | Grade 6 / Grade-in E                         | \$517.00 | COM 1 yard   |
|       |                                   | Evita leather<br>(Black/White/Stone/Vanilla) | \$642.00 | Carton weight 59 pounds<br>UPS weight 100 pounds<br>Arms Group 1 & 4<br>Warranty 12 year limited |



average / medium

| Model  | Description                       | Textile Grade-In                             | List     | Specifications   |
|--------|-----------------------------------|--|----------|--|
| CLS57D | Pneumatic lift                    | Grade 1 / C.O.M.                             | \$448.00 | Overall width 27"  |
|        | Tilting backrest                  | Grade 2 / Grade-in A                         | \$468.00 | Overall height 46" - 57"   |
|        | EZ back height adjustment         | Grade 3 / Grade-in B                         | \$488.00 | Back 18.5" w x 19.5" h   |
|        | Seat depth adjustment             | Grade 4 / Grade-in C                         | \$508.00 | Seat 21" w x 18.5-21.6" d  |
|        | Grande Spider Package             | Grade 5 / Grade-in D                         | \$528.00 | Seat height 25" - 33"  |
|        | Dual-toned oversized soft casters | Grade 6 / Grade-in E                         | \$548.00 | COM 1 yard   |
|        |                                   | Evita leather<br>(Black/White/Stone/Vanilla) | \$673.00 | Carton weight 60 pounds<br>UPS weight 100 pounds<br>Arms Group 1 & 4<br>Warranty 12 year limited |



| Model | Description                       | Textile Grade-In                             | List     | Specifications   |
|-------|-----------------------------------|--|----------|--|
| CLS61 | Pneumatic lift                    | Grade 1 / C.O.M.                             | \$474.00 | Overall width 27"  |
|       | Tilting backrest                  | Grade 2 / Grade-in A                         | \$494.00 | Overall height 46" - 57"   |
|       | EZ back height adjustment         | Grade 3 / Grade-in B                         | \$514.00 | Back 20" w x 21" h   |
|       | Seat depth adjustment             | Grade 4 / Grade-in C                         | \$534.00 | Seat 20.5" w x 16-19.1" d  |
|       | Grande Spider Package             | Grade 5 / Grade-in D                         | \$554.00 | Seat height 25" - 33"  |
|       | Dual-toned oversized soft casters | Grade 6 / Grade-in E                         | \$574.00 | COM 1 yard   |
|       |                                   | Evita leather<br>(Black/White/Stone/Vanilla) | \$699.00 | Carton weight 60 pounds<br>UPS weight 100 pounds<br>Arms Group 1 & 4<br>Warranty 12 year limited |



Besides the stools shown on this page, the AF513 (page 16), DB52 (page 40) and YS73 (page 86) contain the same "CLS control" and GSP understructure (8" cylinder, HD Spider base, 65mm dual-color soft casters).

Chairs that are equipped with the Grande Spider Package – such as the CLS models shown above – may be upgraded to an TLPKG package instead. The charge to do so (from a Grande Spider Package) is \$55.56 and the part code to do so is TLPKG.

Please refer to Options (page 149) for details.

## TLPKG



## GSPPKG (i.e., Grande Spider Package)

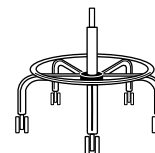

See pages 138 to 149 for a complete listing of all available arm, cylinder, caster, and other ergonomic options. Not all options may be applicable to a given model. Check with OM for compatibility details.

**DESIGN STATEMENT** The design of the CLS Series is based upon a wish list of features that come from various Facility Managers that we've talked to over the years. It has a sturdy base and a comfortable, trouble-free footing, an easy-to-use ratchet back, seat depth adjustment, back angle adjustment and oversized casters that can go anywhere.

The low-maintenance CLS Series is just what the Facility Manager (and the lab technician) ordered!

Above weights do not include optional arm kits. \*UPS weight is calculated using UPS dimensional standards to determine billable weight. †Pricing and specifications subject to change without notification.

## features:

Begins @ \$495 armless / \$604 with KR-200 arms (DB53)

Ideal for ergonomic situations OR environments with heavy side-to-side tasking (i.e., nursing stations)

Unusual backrest shape with functional ergonomic benefits like allowing full back "stretch"

Proprietary DCS™ Technology (double-molded memory foam) standard in most backrest and some seat cushions (check model description for confirmation)

Breadth of mechanism options from fully ergonomic to light, task-oriented adjustability



**DB74**

Pictured here with optional KR-445 arms and Grade 5 Comfort Knit Solids Xanadu upholstery \$909.00 List (as shown)



**DB56**

Pictured here with optional KR-300M arms and Grade 5 Comfort Knit Solids Cappuccino upholstery \$864.00 List (as shown)



**DB78**

Pictured here with optional KR-600 arms and Grade 5 Comfort Knit Solids Cappuccino upholstery \$1,047.00 List (as shown)

→  
Use our  
handy  
stickers to  
mark this  
section.

discovery back  
series (DB)

# discovery back series (DB)

healthcare & lab

Please see pages 41, 138 -149 for arm kits, casters, and other options.

small / medium back

| Model   | Description                  | Textile Grade-In     | List                     | Specifications           |                   |
|---|------------------------------|----------------------|--------------------------|--------------------------|-------------------|
|  | DB53                         | Pneumatic lift       | Grade 1 / C.O.M.         | \$495.00                 | Overall width 25" |
|   | EZ back height adjustment    | Grade 2 / Grade-in A | \$515.00                 | Overall height 35" - 43" |                   |
|   | Infinitely locking seat tilt | Grade 3 / Grade-in B | \$535.00                 | Back 8" & 16" w x 18" h  |                   |
|   | Infinitely locking back tilt | Grade 4 / Grade-in C | \$555.00                 | Seat 20" w x 17-20.1" d  |                   |
|   | Fabric panel back            | Grade 5 / Grade-in D | \$575.00                 | Seat height 16" - 21"    |                   |
|   | Seat depth adjustment        | Grade 6 / Grade-in E | \$595.00                 | COM 1.5 yds.             |                   |
|   | DCS backrest (only)          |                      |                          | Carton weight 49 pounds  |                   |
|   |                              |                      |                          | UPS weight 101 pounds    |                   |
|   |                              |                      | Arms Groups 1 & 4        |                          |                   |
|   |                              |                      | Warranty 12 year limited |                          |                   |

DCS TECHNOLOGY

| Model   | Description                | Textile Grade-In     | List                     | Specifications            |                   |
|---|----------------------------|----------------------|--------------------------|---------------------------|-------------------|
|  | DB64                       | Pneumatic lift       | Grade 1 / C.O.M.         | \$594.00                  | Overall width 25" |
|   | EZ back height adjustment  | Grade 2 / Grade-in A | \$614.00                 | Overall height 36" - 42"  |                   |
|   | Tilting backrest           | Grade 3 / Grade-in B | \$634.00                 | Back 8" & 16" w x 18" h   |                   |
|   | Rocking tilt               | Grade 4 / Grade-in C | \$654.00                 | Seat 21" w x 17.5-20.6" d |                   |
|   | Forward tilting adjustment | Grade 5 / Grade-in D | \$674.00                 | Seat height 17" - 22"     |                   |
|   | Tension knob               | Grade 6 / Grade-in E | \$694.00                 | COM 1.5 yds.              |                   |
|   | Fabric panel back          |                      |                          | Carton weight 56 pounds   |                   |
|   | Seat depth adjustment      |                      |                          | UPS weight 101 pounds     |                   |
| DCS backrest (only)   |                            |                      | Arms Groups 1 & 4        |                           |                   |
|   |                            |                      | Warranty 12 year limited |                           |                   |

DCS TECHNOLOGY

# discovery back series (DB)

Please see pages 41, 138 - 149 for arm kits, casters, and other options.

high back

**Model**

DB57



**Description**

- Pneumatic lift
- EZ back height adjustment
- Infinitely locking seat tilt
- Infinitely locking back tilt
- Fabric panel back
- Seat depth adjustment
- DCS backrest (only)

**DCS** TECHNOLOGY

**Textile Grade-In**

- Grade 1 / C.O.M.
- Grade 2 / Grade-in A
- Grade 3 / Grade-in B
- Grade 4 / Grade-in C
- Grade 5 / Grade-in D
- Grade 6 / Grade-in E

**List**

- \$565.00
- \$585.00
- \$605.00
- \$625.00
- \$645.00
- \$665.00

**Specifications**

- Overall width 27"
- Overall height 39" - 51"
- Back 8" & 16" w x 22" h
- Seat 21" w x 18-21.1" d
- Seat height 16" - 21"
- COM 1.5 yds.
- Carton weight 56 pounds
- UPS weight 101 pounds
- Arms Groups 1 & 4
- Warranty 12 year limited

**Model**

DB68



**Description**

- Pneumatic lift
- EZ back height adjustment
- Tilting backrest
- Rocking tilt
- Forward tilting adjustment
- Tension knob
- Fabric panel back
- Seat depth adjustment
- Infinite forward tilting
- DCS backrest (only)

**DCS** TECHNOLOGY

**Textile Grade-In**

- Grade 1 / C.O.M.
- Grade 2 / Grade-in A
- Grade 3 / Grade-in B
- Grade 4 / Grade-in C
- Grade 5 / Grade-in D
- Grade 6 / Grade-in E

**List**

- \$626.00
- \$646.00
- \$666.00
- \$686.00
- \$706.00
- \$726.00

**Specifications**

- Overall width 27"
- Overall height 41" - 48.5"
- Back 8" & 16" w x 22" h
- Seat 21" w x 18-21.1" d
- Seat height 18" - 23"
- COM 1.5 yds.
- Carton weight 61 pounds
- UPS weight 101 pounds
- Arms Groups 1 & 4
- Warranty 12 year limited

**Model**

DB74



**Description**

- EZ back height adjustment
- Infinitely locking seat tilt
- Infinitely locking back tilt
- Forward tilting adjustment
- Rocking tension adjustment
- Fabric panel back
- Seat depth adjustment
- DCS seat
- DCS backrest

**DCS** TECHNOLOGY

**Textile Grade-In**

- Grade 1 / C.O.M.
- Grade 2 / Grade-in A
- Grade 3 / Grade-in B
- Grade 4 / Grade-in C
- Grade 5 / Grade-in D
- Grade 6 / Grade-in E

**List**

- \$654.00
- \$674.00
- \$694.00
- \$714.00
- \$734.00
- \$754.00

**Specifications**

- Overall width 27"
- Overall height 40" - 49"
- Back 8" & 16" w x 22" h
- Seat 20" w x 17-20.1" d
- Seat height 18" - 23"
- COM 1.5 yds.
- Carton weight 59 pounds
- UPS weight 101 pounds
- Arms Groups 1 & 4
- Warranty 12 year limited

extra-large back

**Model**

DB78



**Description**

- Pneumatic lift
- EZ back height adjustment
- Infinitely locking seat tilt
- Infinitely locking back tilt
- Forward tilting adjustment
- Rocking tension adjustment
- Fabric panel back
- Seat depth adjustment
- Memory foam in backrest
- DCS seat

**DCS** TECHNOLOGY

**Textile Grade-In**

- Grade 1 / C.O.M.
- Grade 2 / Grade-in A
- Grade 3 / Grade-in B
- Grade 4 / Grade-in C
- Grade 5 / Grade-in D
- Grade 6 / Grade-in E

**List**

- \$708.00
- \$728.00
- \$748.00
- \$768.00
- \$788.00
- \$808.00

**Specifications**

- Overall width 27"
- Overall height 43" - 52"
- Back 11" & 22" w x 25" h
- Seat 22" w x 18-21.1" d
- Seat height 18" - 23"
- COM 2 yds.
- Carton weight 64 pounds
- UPS weight 101 pounds
- Arms Groups 1 & 4
- Warranty 12 year limited







# discovery back series (DB)



healthcare & lab

Please see pages 41, 138 -149 for arm kits, casters, and other options.

stools

| Model   | Description                      | Textile Grade-In     | List             | Specifications           |                   |
|---|----------------------------------|----------------------|------------------|--------------------------|-------------------|
|  | DB52                             | Pneumatic lift       | Grade 1 / C.O.M. | \$541.00                 | Overall width 27" |
|   | EZ back height adjustment        | Grade 2 / Grade-in A | \$561.00         | Overall height 43" - 54" |                   |
|   | Infinitely locking back tilt     | Grade 3 / Grade-in B | \$581.00         | Back 8" & 16" w x 18" h  |                   |
|   | Fabric panel back                | Grade 4 / Grade-in C | \$601.00         | Seat 20" w x 17-20.1" d  |                   |
|   | Seat depth adjustment            | Grade 5 / Grade-in D | \$621.00         | Seat height 25" - 33"    |                   |
|   | Grande Spider Package            | Grade 6 / Grade-in E | \$641.00         | COM 1.5 yds.             |                   |
|   | Dual-tone oversized soft casters |                      |                  | Carton weight 56 pounds  |                   |
|   | DCS backrest (only)              |                      |                  | UPS weight 100 pounds    |                   |
|   |                                  |                      |                  | Arms Groups 1 & 4        |                   |
|   |                                  |                      |                  | Warranty 12 year limited |                   |
|  |                                  |                      |                  |                          |                   |

| Model  | Description                      | Textile Grade-In     | List             | Specifications           |                   |
|--|----------------------------------|----------------------|------------------|--------------------------|-------------------|
|  | DB54                             | Pneumatic lift       | Grade 1 / C.O.M. | \$606.00                 | Overall width 27" |
|  | EZ back height adjustment        | Grade 2 / Grade-in A | \$626.00         | Overall height 41" - 54" |                   |
|  | Infinitely locking back tilt     | Grade 3 / Grade-in B | \$646.00         | Back 8" & 16" w x 18" h  |                   |
|  | Fabric panel back                | Grade 4 / Grade-in C | \$666.00         | Seat 21" w x 18-21.1" d  |                   |
|  | Seat depth adjustment            | Grade 5 / Grade-in D | \$686.00         | Seat height 23" - 33"    |                   |
|  | Turn-lock footring               | Grade 6 / Grade-in E | \$706.00         | COM 1.5 yds.             |                   |
|  | Titanium colored metal base      |                      |                  | Carton weight 54 pounds  |                   |
|  | Dual-tone oversized soft casters |                      |                  | UPS weight 101 pounds    |                   |
|  | DCS backrest (only)              |                      |                  | Arms Groups 1 & 4        |                   |
|  |                                  |                      |                  | Warranty 12 year limited |                   |
|  |                                  |                      |                  |                          |                   |

| Model   | Description                      | Textile Grade-In     | List             | Specifications           |                   |
|---|----------------------------------|----------------------|------------------|--------------------------|-------------------|
|  | DB56                             | Pneumatic lift       | Grade 1 / C.O.M. | \$618.00                 | Overall width 27" |
|   | EZ back height adjustment        | Grade 2 / Grade-in A | \$638.00         | Overall height 45" - 58" |                   |
|   | Infinitely locking back tilt     | Grade 3 / Grade-in B | \$658.00         | Back 8" & 16" w x 22" h  |                   |
|   | Fabric panel back                | Grade 4 / Grade-in C | \$678.00         | Seat 21" w x 18-21.1" d  |                   |
|   | Seat depth adjustment            | Grade 5 / Grade-in D | \$698.00         | Seat height 23" - 33"    |                   |
|   | Turn-lock footring               | Grade 6 / Grade-in E | \$718.00         | COM 1.5 yds.             |                   |
|   | Titanium colored metal base      |                      |                  | Carton weight 59 pounds  |                   |
|   | Dual-tone oversized soft casters |                      |                  | UPS weight 101 pounds    |                   |
|   | DCS backrest (only)              |                      |                  | Arms Groups 1 & 4        |                   |
|   |                                  |                      |                  | Warranty 12 year limited |                   |
|  |                                  |                      |                  |                          |                   |



Please see pages 138 - 149 for arm kits, casters, and other options.

common options

## Suggested Options for DB Series

### Arms kits

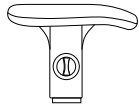

**KR-21** - list: 65.00  
 Contoured height adjustable T arms  
 Adjustable height range of 2.25"  
 12 year limited warranty on the arm frame.  
 2 year limited warranty on the arm pad.



**KR445** - list: 175.00  
 Height and width adjustable T-arms with smooth fore-aft, side-to-side, and pivoting motion arm caps  
 Adjustable width range of approx. 1.25" per side  
 12 year limited warranty on arm frames &  
 2 year limited warranty on arm pads.



**KR251M** - list: 185.00  
 Ultra-mobility arms with extension, 3-stage swivel and unlimited inside pivoting on the lowest height and width adjustable and removable T arms.  
 Overall height travel: 6.9-9.5" from seat cushion (varies) 2" width travel/side  
 Memosoft arm pads  
 12 year limited warranty on arm frames &  
 2 year limited warranty on arm pads.



**KR465** - list: 195.00  
 Height and width adjustable T-arms with lockable fore-aft, side-to-side, and pivoting motion arm caps  
 Adjustable width range of approximately 1.25" per side  
 12 year limited warranty on arm frames &  
 2 year limited warranty on arm pads

See pages 138 to 149 for a complete listing of all available arm, cylinder, caster, and other ergonomic options. Not all options may be applicable to a given model. Check with OM for compatibility details.

**DISCOVERY BACK DESIGN BENEFITS** The special pear-back design of our Discovery Back series is designed specifically to address unhealthy seating postures. With a cut-away design to allow for full rearward travel of the scapula, DB chairs can help users who sit for long hours to develop habits for a healthier back.

**SCAPULAR IMPEDANCE** When reclining against a traditional backrest the shoulders are restricted from their full range of motion. This restriction of motion is referred to as scapular impedance, a condition that impedes the full range of motion and prevents beneficial stretching.

**THE 'HEALTHY BACK' DESIGN** According to the ergonomists and chiropractors with whom we have consulted, when people are seated in a chair with a full, 'normal' backrest, the body has a natural tendency to hunch forward. This predilection towards 'scrunching' is — with near uniform agreement — recognized as an unhealthy position for the human body to remain in, especially when seen in prolonged seating situations.

**NOTES** When upholstered in OM Comfort Knit Solids or Matrix fabrics, DB Series back shells are upholstered in a high double-rub black fabric unless otherwise specified.

Adding adjustable lumbar is an option on any DB Series model except for the DB52, DB53, DB54, DB64. The DB64, DB68, DB74, and DB78 are rated for 300 lb. weight capacity.



multi-shift | intense-use  
heavy-duty

# intensive use 24-seven (IU)

## features:

Begins @ \$546 armless / \$655 with KR-200 arms (IU54)

Ever feel like you're working 28 hours/day? IU and IUHD chairs are right there with you!

Aesthetic complement to the PT series, but with long-lasting &/or heavy-duty parts

Engineered composite bases, heavy-duty reinforced cylinders and mechanisms

Proprietary DCS™ Technology (double-molded memory foam) standard in IUHD seats



### IU55

Pictured here with optional  
Grade 3 Stage Aida upholstery  
\$632.00 List (as shown)



### IUHD Series

An intensive-use and heavy-duty  
application series with multiple adjustments.  
Series starts at \$777.00 List



### IU76PD

Pictured here with optional JR-PD arms and  
Grade 1 Spice Nutmeg upholstery  
\$1,124.00 List (as shown)

→  
Use our  
handy  
stickers to  
mark this  
section.

intensive use  
24-seven  
(IU)

# intensive use 24-seven (IU)

multi-shift | intense-use

Please see pages 45, 138 -149 for arm kits, casters, and other options.

average / medium

| Model | Description                                | Textile Grade-In     | List     | Specifications           |
|-------|--|----------------------|----------|--------------------------|
| IU54  | Pneumatic lift                             | Grade 1 / C.O.M.     | \$546.00 | Overall width 27"        |
|       | EZ back height adjustment                  | Grade 2 / Grade-in A | \$561.00 | Overall height 38" - 47" |
|       | Independent seat and back angle adjustment | Grade 3 / Grade-in B | \$576.00 | Back 20" w x 20" h       |
|       |  | Grade 4 / Grade-in C | \$591.00 | Seat 21" w x 17.9-21" d  |
|       | Seat depth adjustment                      | Grade 5 / Grade-in D | \$606.00 | Seat height 17" - 22"    |
|       | Flat panel back                            | Grade 6 / Grade-in E | \$621.00 | COM 1.5 yds.             |
|       |  |                      |          | Carton weight 48 pounds  |
|       |  |                      |          | UPS weight 101 pounds    |
|       |  |                      |          | Arms Groups 1 & 4        |
|       |  |                      |          | Warranty 7 year limited  |



300 POUNDS CAPACITY

| Model | Description                                | Textile Grade-In     | List     | Specifications           |
|-------|--|----------------------|----------|--------------------------|
| IU72  | Pneumatic lift                             | Grade 1 / C.O.M.     | \$546.00 | Overall width 27"        |
|       | EZ back height adjustment                  | Grade 2 / Grade-in A | \$561.00 | Overall height 36" - 45" |
|       | Independent seat and back angle adjustment | Grade 3 / Grade-in B | \$576.00 | Back 17" w x 18" h       |
|       |  | Grade 4 / Grade-in C | \$591.00 | Seat 20" w x 17-20.1" d  |
|       | Seat depth adjustment                      | Grade 5 / Grade-in D | \$606.00 | Seat height 17" - 22"    |
|       |  | Grade 6 / Grade-in E | \$621.00 | COM 1 yd.                |
|       |  |                      |          | Carton weight 54 pounds  |
|       |  |                      |          | UPS weight 101 pounds    |
|       |  |                      |          | Arms Groups 1 & 4        |
|       |  |                      |          | Warranty 7 year limited  |



300 POUNDS CAPACITY

large

| Model | Description                                | Textile Grade-In     | List     | Specifications           |
|-------|--|----------------------|----------|--------------------------|
| IU58  | Pneumatic lift                             | Grade 1 / C.O.M.     | \$589.00 | Overall width 27"        |
|       | EZ back height adjustment                  | Grade 2 / Grade-in A | \$604.00 | Overall height 43" - 52" |
|       | Independent seat and back angle adjustment | Grade 3 / Grade-in B | \$619.00 | Back 20" w x 24" h       |
|       |  | Grade 4 / Grade-in C | \$634.00 | Seat 21" w x 17.9-21" d  |
|       | Seat depth adjustment                      | Grade 5 / Grade-in D | \$649.00 | Seat height 17" - 22"    |
|       | Fabric panel back                          | Grade 6 / Grade-in E | \$664.00 | COM 2 yds.               |
|       |  |                      |          | Carton weight 55 pounds  |
|       |  |                      |          | UPS weight 101 pounds    |
|       |  |                      |          | Arms Groups 1 & 4        |
|       |  |                      |          | Warranty 7 year limited  |



300 POUNDS CAPACITY

| Model | Description                                | Textile Grade-In     | List     | Specifications           |
|-------|--|----------------------|----------|--------------------------|
| IU76  | Pneumatic lift                             | Grade 1 / C.O.M.     | \$589.00 | Overall width 27"        |
|       | EZ back height adjustment                  | Grade 2 / Grade-in A | \$604.00 | Overall height 40" - 48" |
|       | Independent seat and back angle adjustment | Grade 3 / Grade-in B | \$619.00 | Back 19.5" w x 22" h     |
|       |  | Grade 4 / Grade-in C | \$634.00 | Seat 21" w x 18-21.1" d  |
|       | Seat depth adjustment                      | Grade 5 / Grade-in D | \$649.00 | Seat height 17" - 22"    |
|       |  | Grade 6 / Grade-in E | \$664.00 | COM 1.5 yds.             |
|       |  |                      |          | Carton weight 57 pounds  |
|       |  |                      |          | UPS weight 101 pounds    |
|       |  |                      |          | Arms Groups 1 & 4        |
|       |  |                      |          | Warranty 7 year limited  |



300 POUNDS CAPACITY

omsmartseating.com

SMART SEATING



# intensive use 24-seven (IU)



Please see pages 138 - 149 for arm kits, casters, and other options.

stools

| Model  | Description                                | Textile Grade-In     | List     | Specifications           |
|--|--|----------------------|----------|--------------------------|
| <b>IU55</b><br> | Pneumatic lift                             | Grade 1 / C.O.M.     | \$602.00 | Overall width 27"        |
|  | EZ back height adjustment                  | Grade 2 / Grade-in A | \$617.00 | Overall height 45" - 59" |
|  | Independent seat and back angle adjustment | Grade 3 / Grade-in B | \$632.00 | Back 20" w x 20" h       |
|  | Seat depth adjustment                      | Grade 4 / Grade-in C | \$647.00 | Seat 21" w x 17-20.1" d  |
|  | Fabric panel back                          | Grade 5 / Grade-in D | \$662.00 | Seat height 24" - 34"    |
|  | 20" chrome footring                        | Grade 6 / Grade-in E | \$677.00 | COM 1.5 yds.             |
|  | Patented Turn-Lock footring                |                      |          | Carton weight 53 pounds  |
|  | Optional 8" cylinder available (21" - 29") |                      |          | UPS weight 101 pounds    |
|  |  |                      |          | Arms Groups 1 & 4        |
|  |  |                      |          | Warranty 7 year limited  |

| Model  | Description                                | Textile Grade-In     | List     | Specifications           |
|--|--|----------------------|----------|--------------------------|
| <b>IU73</b><br> | Pneumatic lift                             | Grade 1 / C.O.M.     | \$602.00 | Overall width 27"        |
|  | EZ back height adjustment                  | Grade 2 / Grade-in A | \$617.00 | Overall height 43" - 57" |
|  | Independent seat and back angle adjustment | Grade 3 / Grade-in B | \$632.00 | Back 17" w x 18" h       |
|  | Seat depth adjustment                      | Grade 4 / Grade-in C | \$647.00 | Seat 20" w x 17-20.1" d  |
|  | 20" chrome footring                        | Grade 5 / Grade-in D | \$662.00 | Seat height 24" - 34"    |
|  | Patented Turn-Lock footring                | Grade 6 / Grade-in E | \$677.00 | COM 1 yd.                |
|  | Optional 8" cylinder available (21" - 29") |                      |          | Carton weight 59 pounds  |
|  |  |                      |          | UPS weight 101 pounds    |
|  |  |                      |          | Arms Groups 1 & 4        |
|  |  |                      |          | Warranty 7 year limited  |

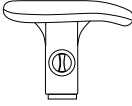
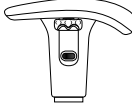
common options

| Arms kits   |   |   |   |
|---|---|---|---|
|  | <b>KR-21</b> - list: 65.00<br>Contoured height adjustable T arms<br>Adjustable height range of 2.25"<br>12 year limited warranty on the arm frame.<br>2 year limited warranty on the arm pad. |  | <b>KR-25</b> - list: 79.00<br>Contoured height adjustable T-arms featuring natural grip control. Adjustable height range of 2.75". 12 year limited warranty on arm frames & 2 year limited warranty on arm pads*  |
|   |    |   | <b>KR-200</b> - list: 109.00<br>Height and width adjustable and removable T-arms with natural grip control. Adjustable height range of 2.75". Adjustable width range of approximately 1.25" per side. 12 year limited warranty on arm frames & 2 year limited warranty on arm pads* |

See pages 138 to 149 for a complete listing of all available arm, cylinder, caster, and other ergonomic options. Not all options may be applicable to a given model. Check with OM for compatibility details.

Intensive Use 24-Seven Series designed to accommodate users up to 300 pounds.  
 IU: Intensive Use (aka, 24/7 environments), HD: Heavy-Duty (i.e. for occupants weighing up to 350 lbs.)



# intensive use 24-seven (IUHD)

heavy-duty

Please see pages 47, 138 -149 for arm kits, casters, and other options.

average / mid back

## Model

### IU76HD



## Description

DCS TECHNOLOGY

Pneumatic lift  
Tilting backrest  
EZ back height adjustment  
Rocking tilt  
Seat tilting  
Seat depth adjustment  
Heavy-duty structure  
Dual-tone oversized soft casters  
DCS seat

## Textile Grade-In

Grade 1 / C.O.M. \$777.00  
Grade 2 / Grade-in A \$797.00  
Grade 3 / Grade-in B \$817.00  
Grade 4 / Grade-in C \$837.00  
Grade 5 / Grade-in D \$857.00  
Grade 6 / Grade-in E \$877.00

## List

## Specifications

Overall width 28"  
Overall height 40" - 48"  
Back 19.5" w x 22" h  
Seat 22" w x 18-21.1" d  
Seat height 17" - 22"  
COM 1.5 yds.  
Carton weight 57 pounds  
UPS weight 101 pounds  
Arms Groups 1 & 4  
Warranty 7 year limited

## Model

### IU76PD



## Description

DCS TECHNOLOGY

Pneumatic lift  
Tilting backrest  
EZ back height adjustment  
Rocking tilt  
Seat tilting  
Seat depth adjustment  
Heavy-duty structure  
Lower back reinforced with ballistic nylon  
Dual-tone oversized soft casters  
DCS seat

## Textile Grade-In

Grade 1 / C.O.M. \$867.00  
Grade 2 / Grade-in A \$887.00  
Grade 3 / Grade-in B \$907.00  
Grade 4 / Grade-in C \$927.00

## List

## Specifications

Overall width 28"  
Overall height 40" - 48"  
Back 19.5" w x 22" h  
Seat 22" w x 18-21.1" d  
Seat height 17" - 22"  
COM 1.5 yds.  
Carton weight 57 pounds  
UPS weight 101 pounds  
Arms Groups 1 & 4  
Warranty 7 year limited

large / xtra tall

## Model

### IU79HD



## Description

DCS TECHNOLOGY

Pneumatic lift  
Tilting backrest  
EZ back height adjustment  
Rocking tilt  
Seat tilting  
Seat depth adjustment  
Heavy-duty structure  
Dual-tone oversized soft casters  
DCS seat

## Textile Grade-In

Grade 1 / C.O.M. \$821.00  
Grade 2 / Grade-in A \$841.00  
Grade 3 / Grade-in B \$861.00  
Grade 4 / Grade-in C \$881.00  
Grade 5 / Grade-in D \$901.00  
Grade 6 / Grade-in E \$921.00

## List

## Specifications

Overall width 28"  
Overall height 45" - 53"  
Back 19.5" w x 28" h  
Seat 22" w x 18-21.1" d  
Seat height 17" - 22"  
COM 1.5 yds.  
Carton weight 63 pounds  
UPS weight 195 pounds  
Arms Groups 1 & 4  
Warranty 7 year limited

## Model

### IU79PD



## Description

DCS TECHNOLOGY

Pneumatic lift  
Tilting backrest  
EZ back height adjustment  
Rocking tilt  
Seat tilting  
Seat depth adjustment  
Heavy-duty structure  
Lower back reinforced with ballistic nylon  
Dual-tone oversized soft casters  
DCS seat

## Textile Grade-In\*

Grade 1 / C.O.M. \$914.00  
Grade 2 / Grade-in A \$934.00  
Grade 3 / Grade-in B \$954.00  
Grade 4 / Grade-in C \$974.00

## List

## Specifications

Overall width 28"  
Overall height 48" - 53"  
Back 19.5" w x 28" h  
Seat 22" w x 18-21.1" d  
Seat height 17" - 22"  
COM 1.5 yds.  
Carton weight 63 pounds  
UPS weight 195 pounds  
Arms Groups 1 & 4  
Warranty 7 year limited

multi-shift  
intense-use

# intensive use 24-seven (IUPD)

Please see pages 138 - 149 for arm kits, casters, and other options.

stools

| Model  | Description                                | DCS TECHNOLOGY | Textile Grade-In*    | List     | Specifications           |
|--------|--|----------------|----------------------|----------|--------------------------|
| IU77HD | Pneumatic lift                             |                | Grade 1 / C.O.M.     | \$842.00 | Overall width 28"        |
|        | EZ back height adjustment                  |                | Grade 2 / Grade-in A | \$862.00 | Overall height 45" - 57" |
|        | Independent seat and back angle adjustment |                | Grade 3 / Grade-in B | \$882.00 | Back 19.5" w x 22" h     |
|        |  |                | Grade 4 / Grade-in C | \$902.00 | Seat 22" w x 18-21.1" d  |
|        | Patented Turn-Lock footring                |                | Grade 5 / Grade-in D | \$922.00 | Seat height 22" - 30"    |
|        | Seat depth adjustment                      |                | Grade 6 / Grade-in E | \$942.00 | COM 1.5 yds.             |
|        | 20" chrome footring                        |                |                      |          | Carton weight 63 pounds  |
|        | Heavy-duty structure                       |                |                      |          | UPS weight 101 pounds    |
|        | Dual-tone oversized soft casters           |                |                      |          | Arms Groups 1 & 4        |
|        | DCS seat                                   |                |                      |          | Warranty 7 year limited  |



350  
POUNDS  
CAPACITY

| Model                                      | Description                                | DCS TECHNOLOGY | Textile Grade-In*    | List                    | Specifications           |
|--|--|----------------|----------------------|-------------------------|--------------------------|
| IU77PD                                     | Pneumatic lift with 8" cylinder only       |                | Grade 1 / C.O.M.     | \$932.00                | Overall width 28"        |
|  | EZ back height adjustment                  |                | Grade 2 / Grade-in A | \$952.00                | Overall height 45" - 57" |
|  | Independent seat and back angle adjustment |                | Grade 3 / Grade-in B | \$972.00                | Back 19.5" w x 22" h     |
|  |  |                | Grade 4 / Grade-in C | \$992.00                | Seat 22" w x 18-21.1" d  |
|  | Patented Turn-Lock footring                |                |                      |                         | Seat height 22" - 30"    |
|  | Seat depth adjustment                      |                |                      |                         | COM 1.5 yds.             |
| 20" chrome footring                        |  |                |                      | Carton weight 63 pounds |                          |
| Heavy-duty structure                       |  |                |                      | UPS weight 101 pounds   |                          |
| Lower back reinforced with ballistic nylon |  |                |                      | Arms Groups 1 & 4       |                          |
| DCS seat                                   |  |                |                      | Warranty 7 year limited |                          |



350  
POUNDS  
CAPACITY

common options

### Suggested Options for IUHD/IUPD Series

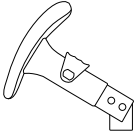
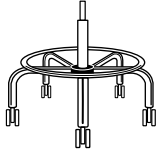
|   |  |  |
|---|--|--|
|  | <b>Arms kits</b><br><b>JR-BN/JR-PD</b> - list: 257.00<br>Height adjustable T-arms with fold back feature and trigger-style control<br>Adjustable height range of 2.25"<br>Ballistic nylon upholstered arm pads (on JR-BN)<br>Memosoft arm pads (on JR-PD)<br>12 year limited warranty on the arm frame.<br>2 year limited warranty on the arm pad. |  <b>GSPPKG</b> - list: 55.56<br>Must use CYL-6SHD<br>(Alternate stool base option for IU77HD/PD - no charge to substitute) |
|   | <b>JR-69</b> - list: 206.00<br>2-way adjustable (W/H) forward-slanting T-arms with RP65 lockable arm pads.<br>Black only.<br>Adjustable height range of 4.25"<br>Adjustable width range of 1.75"<br>12 year limited warranty on the arm frame.<br>2 year limited warranty on the arm pad.  |  |

Intensive Use 24-Seven Heavy-Duty Series designed to accommodate users up to 350 pounds.

IU: Intensive Use (aka, 24/7 environments)

HD: Heavy-Duty (i.e. for occupants weighing up to 350 lbs.)

PD: Police Department (i.e., perfect for police or security environments)

\*Application testing may be required for Grade-In fabrics on IUPD and MXPD seating. Consult OM for details.

Above weights do not include optional arm kits. ; UPS weight is calculated using UPS dimensional standards to determine billable weight. ; Pricing and specifications subject to change without notification.





multi-shift  
heavy-duty

# maxwell intensive use 24-seven (MXIU)

## features:

Begins @ \$867 armless / \$976 with KR-200 arms (MX84IU)

Our heaviest chair both by weight and weight-rating is scaled and built to comfortably support up to 450 lbs.

Relatively slim backrest design has a useful trapezoidal shape that creates less exaggerated aesthetics

24" wide seat, steel seat plate & extra heavy-duty components make this a strong choice



**MXIU**

OM's heaviest-duty seating series that is also rated for 24/7 use. Series starts at \$867.00 List



**7878MX**

Pictured here with Grade 3 Symphony Piano upholstery \$946.00 List (as shown)



**MX88PD**

Pictured here with optional JR-BN arms and Grade 1 Spice Sesame upholstery \$1,264.00 List (as shown)

→  
Use our  
handy  
stickers to  
mark this  
section.

49

maxwell  
intensive use  
(MXIU & MXPD)

# maxwell intensive use 24-seven (MXIU) multi-shift heavy-duty

Please see pages 138 -149 for arm kits, casters, and other options.

average / medium

## Model

### MX84IU



## Description

- Pneumatic lift
- Tilting backrest
- EZ back height adjustment
- Rocking tilt
- Tension knob
- Fabric panel back
- Trim wide-back design
- Seat depth adjustment
- Dual-tone oversized soft casters

## Textile Grade-In

- Grade 1 / C.O.M. \$867.00
- Grade 2 \$887.00
- Grade 3 / Grade-in A \$907.00
- Grade 4 / Grade-in B \$927.00
- Grade 5 / Grade-in C \$947.00
- Grade 6 / Grade-in D \$967.00

## List

## Specifications

- Overall width 28"
- Overall height 38" - 47"
- Back 23.5" w x 20" h
- Seat 24" w x 17-19.5" d
- Seat height 18" - 23"
- COM 1.5 yds.
- Carton weight 63 pounds
- UPS weight 195 pounds
- Arms Group 1 (no ETR1)
- Warranty 7 year limited

## Model

### MX84PD



## Description

- Pneumatic lift
- Tilting backrest
- EZ back height adjustment
- Rocking tilt
- Tension knob
- Fabric panel back (Ballistic Nylon)
- Trim wide-back design
- Seat depth adjustment
- Dual-tone oversized soft casters

## Textile Grade-In

- Grade 1 / C.O.M. \$959.00
- Grade 2 / Grade-in A \$979.00
- Grade 3 / Grade-in B \$999.00
- Grade 4 / Grade-in C \$1,019.00

## List

## Specifications

- Overall width 28"
- Overall height 38" - 47"
- Back 23.5" w x 20" h
- Seat 24" w x 17-19.5" d
- Seat height 18" - 23"
- COM 1.5 yds.
- Carton weight 63 pounds
- UPS weight 195 pounds
- Arms Groups 1 (no ETR1)
- Warranty 7 year limited

large / xtra tall

## Model

### MX88IU



## Description

- Pneumatic lift
- Tilting backrest
- EZ back height adjustment
- Rocking tilt
- Tension knob
- Fabric panel back
- Trim wide-back design
- Seat depth adjustment
- Dual-tone oversized soft casters

## Textile Grade-In

- Grade 1 / C.O.M. \$915.00
- Grade 2 \$935.00
- Grade 3 / Grade-in A \$955.00
- Grade 4 / Grade-in B \$975.00
- Grade 5 / Grade-in C \$995.00
- Grade 6 / Grade-in D \$1,015.00

## List

## Specifications

- Overall width 28"
- Overall height 43" - 52"
- Back 23.5" w x 25" h
- Seat 24" w x 17-19.5" d
- Seat height 18" - 23"
- COM 2 yds.
- Carton weight 68 pounds
- UPS weight 195 pounds
- Arms Group 1 (no ETR1)
- Warranty 7 year limited

## Model

### MX88PD



## Description

- Pneumatic lift
- Tilting backrest
- EZ back height adjustment
- Rocking tilt
- Tension knob
- Fabric panel back (Ballistic Nylon)
- Trim wide-back design
- Seat depth adjustment
- Dual-tone oversized soft casters

## Textile Grade-In

- Grade 1 / C.O.M. \$1,007.00
- Grade 2 / Grade-in A \$1,027.00
- Grade 3 / Grade-in B \$1,047.00
- Grade 4 / Grade-in C \$1,067.00

## List

## Specifications

- Overall width 28"
- Overall height 43" - 52"
- Back 23.5" w x 25" h
- Seat 24" w x 17-19.5" d
- Seat height 18" - 23"
- COM 2 yds.
- Carton weight 68 pounds
- UPS weight 195 pounds
- Arms Groups 1 (no ETR1)
- Warranty 7 year limited

Maxwell available for users up to 450 lbs.

\*If purchasing arms separate (as a retrofit option), use special, heavier-duty bolts.

Arms should normally be installed by OM or its authorized dealers.

\*Application testing may be required for Grade-In fabrics on IUPD and MXPD seating. Consult OM for details.

**MX: Max Heavy-Duty (i.e., users up to 450 lbs.)**

**PD: Police Department (i.e., perfect for police or security environments)**

multi-shift heavy-duty | maxwell intensive use 24-seven (MXPD)

Please see pages 138 - 149 for arm kits, casters, and other options.

variations & stools

| Model [NEW]   | Description  | Textile Grade-In  | List       | Specifications                         |
|---|--|---|------------|--|
|  <p><b>MX85IU</b></p> <p>ups<br/>oversize</p> <p>450<br/>POUNDS<br/>CAPACITY</p> | Pneumatic lift   | Grade 1 / C.O.M.  | \$959.00   | Overall width 32"                      |
|   | Tilting backrest                                       | Grade 2   | \$979.00   | Overall height 49.5" - 59.5"           |
|   | EZ back height adjustment                              | Grade 3 / Grade-in A  | \$999.00   | Back 23.5" w x 20" h                   |
|   | Rocking tilt   | Grade 4 / Grade-in B  | \$1,019.00 | Seat 24" w x 17-19.5" d                |
|   | Tension knob   | Grade 5 / Grade-in C  | \$1,039.00 | Seat height 28" - 34.5"                |
|   | Fabric panel back                                      | Grade 6 / Grade-in D  | \$1,059.00 | COM 1.5 yds.                           |
|   | Trim wide-back design                                  | *Ships with chair top and spider base in 2 separate cartons |            | Carton weight 57 pounds / 18.2 pounds* |
|   | Seat depth adjustment                                  |   |            | UPS weight 195 pounds / 59 pounds      |
|   | Upsize Grande Spider Package                           | Arms Group 1 (no ETR1)                                      |            |  |
|   | 6" Super HD cylinder and glides (upcharge for casters) | Warranty 7 year limited                                     |            |  |

| Model [NEW]   | Description  | Textile Grade-In  | List       | Specifications                         |
|---|--|---|------------|--|
|  <p><b>MX87IU</b></p> <p>ups<br/>oversize</p> <p>450<br/>POUNDS<br/>CAPACITY</p> | Pneumatic lift   | Grade 1 / C.O.M.  | \$1,007.00 | Overall width 32"                      |
|   | Tilting backrest                                       | Grade 2   | \$1,027.00 | Overall height 54.5" - 64.5"           |
|   | EZ back height adjustment                              | Grade 3 / Grade-in A  | \$1,047.00 | Back 23.5" w x 25" h                   |
|   | Rocking tilt   | Grade 4 / Grade-in B  | \$1,067.00 | Seat 24" w x 17-19.5" d                |
|   | Tension knob   | Grade 5 / Grade-in C  | \$1,087.00 | Seat height 28" - 34.5"                |
|   | Fabric panel back                                      | Grade 6 / Grade-in D  | \$1,107.00 | COM 2 yds.                             |
|   | Trim wide-back design                                  | *Ships with chair top and spider base in 2 separate cartons |            | Carton weight 62 pounds / 18.2 pounds* |
|   | Seat depth adjustment                                  |   |            | UPS weight 195 pounds / 59 pounds      |
|   | Upsize Grande Spider Package                           | Arms Group 1 (no ETR1)                                      |            |  |
|   | 6" Super HD cylinder and glides (upcharge for casters) | Warranty 7 year limited                                     |            |  |

| Model [NEW]   | Description                      | Textile Grade-In  | List       | Specifications               |
|---|----------------------------------|---|------------|------------------------------|
|  <p><b>7878MX</b></p> <p>ups<br/>oversize</p> <p>450<br/>POUNDS<br/>CAPACITY</p> | Pneumatic lift                   | Grade 1 / C.O.M.  | \$906.00   | Overall width 28"            |
|   | Tilting backrest                 | Grade 2   | \$926.00   | Overall height 42.5" - 50.5" |
|   | EZ back height adjustment        | Grade 3 / Grade-in A  | \$946.00   | Back 18" w x 23" h           |
|   | Rocking tilt                     | Grade 4 / Grade-in B  | \$966.00   | Seat 24" w x 17-19.5" d      |
|   | Tension knob                     | Grade 5 / Grade-in C  | \$986.00   | Seat height 18" - 23"        |
|   | Executive trim-back design       | Grade 6 / Grade-in D  | \$1,006.00 | COM 2 yds.                   |
|   | Seat depth adjustment            | *Ships with chair top and spider base in 2 separate cartons |            | Carton weight 68 pounds      |
|   | Dual-tone oversized soft casters |   |            | UPS weight 195 pounds        |
|   |                                  | Arms Group 1 (no ETR1)                                      |            |                              |
|   |                                  | Warranty 7 year limited                                     |            |                              |

**DESIGN STATEMENT** Called the "Maxwell" for its MAX-size and WELL-structured construction, these chairs are big in so many aspects. Made of heavy-duty components from top to bottom, these full-size chairs with wide-back comfort and solid design are ideal for users up to 450 pounds.

The Maxwell is built to endure, and now redesigned with a tapered top and wide-based back rest to offer the same full support but with a less daunting appearance.



## features:

Begins @ \$668 armless / \$766 with OM5 arms (OM5-B)

A "modern classic" ideal for working environments from task to executive suites & boardrooms

"Body-Activated Motion" responds to users' weight without cumbersome tension knob

Designed by Francisco Romero of Phidesign

Proprietary features such as Virtual Pause, Variable Back Response, Waterfall Flex, etc.

→  
Use our  
handy  
stickers to  
mark this  
section.  
OM5 series®



### OM5 Task Chair

Pictured here with optional arms  
and COM seat upholstery  
\$854.00 List (as shown)



### OM5 Xtra Tall (XT)

Pictured here with optional arms  
and Taurus Zodiac Mesh &  
COM seat/back upholstery  
\$884.00 List (as shown)



### OM5 Executive High Back (EX)

Pictured here with optional arms  
and COM upholstery  
\$982.00 List (as shown)



**OM5 Mid-Back**

## OM5 series® work chair

### DESCRIPTION

- Regular back
- Regular seat (with waterfall flex feature)
- OM5 series® body-activated motion
- Virtual pause/lock
- Polyflex with variable back resistance

## Specifications

| MODEL          | MID-BACK                                       |
|----------------|--|
| Overall width  | 27"  |
| Overall height | 37" - 42"                                      |
| Back           | 18" w -21 h"                                   |
| Seat           | 19.75" w x 17-18.5" d<br>(16-17.5" d back uph) |
| Seat height    | 16 -21"  |
| COM            | .75 yd. seat<br>.75 yd. back                   |
| Carton weight  | 64 pounds                                      |
| UPS weight     | 101 pounds                                     |
| Arms           | Optional                                       |
| Warranty       | Lifetime Limited                               |
| Weight Rating  | 300 lbs.                                       |

## Order your chair worksheet

| CATEGORY              | CODE | PRICE |
|-----------------------|------|-------|
| 1. Model type / color |      |       |
| 2. Arms               |      |       |
| 3. Poly-Flex Back     |      |       |
| 4. Back Upholstery    |      |       |
| 5. Seat Upholstery    |      |       |
| 6. Cylinder           |      |       |
| 7. Base               |      |       |
| 8. Casters            |      |       |
| 9. Other Options      |      |       |

Unit Price

+ Number of Chairs

= Total Cost for Chairs

## 1. Model

| FRAME COLOR                          | CODE         | PRICE    |
|--------------------------------------|--------------|----------|
| <input type="radio"/> Modern Black   | <b>OM5-B</b> | \$668.00 |
| <input type="radio"/> Palladium Grey | <b>OM5-G</b> | \$768.00 |



## 2. Arms

| ARMS   | CODE        | PRICE    |
|--|-------------|----------|
| <input type="radio"/> No Arms  | <b>N</b>    | + \$0    |
| <input type="radio"/> With height adjustable OM5 Arms  | <b>A</b>    | + \$98   |
| <input type="radio"/> With ht./width, fore/aft, inward pivot Arms. Code: RP45 multi-adjustable   | <b>RP45</b> | + \$148* |
| <input type="radio"/> With ht./width, fore/aft, pivot Arms Code: RP50 fully-adjustable           | <b>RP50</b> | + \$198* |
| <input type="radio"/> With ht./width, fore/aft, pivot Arms Code: RP65 fully-adjustable, lockable | <b>RP65</b> | + \$208* |

\* List Prices Include OM5 Arm Frame and respective Arm Top

## 3. Poly Flex Back

| POLY FLEX COLOR                      | CODE      | PRICE |
|--------------------------------------|-----------|-------|
| <input type="radio"/> Modern Black   | <b>PB</b> | + \$0 |
| <input type="radio"/> Palladium Grey | <b>PG</b> | + \$0 |
| <input type="radio"/> Arctic White   | <b>PW</b> | + \$0 |

## 4. Back Upholstery Material

| BACK UPHOLSTERY   | CODE                  | PRICE      |
|---|-----------------------|------------|
| <input type="radio"/> Not Upholstered                           | <b>PF</b>             | + \$0      |
| <input type="radio"/> Zodiac Mesh**                             | <b>2300-2310</b>      | + \$38.00  |
| <input type="radio"/> Grade 1 / C.O.M.                          | <b>Fabric Color #</b> | + \$66.00  |
| <input type="radio"/> Grade 2 / Grade-in A                      | <b>Fabric Color #</b> | + \$71.00  |
| <input type="radio"/> Grade 3 / Grade-in B                      | <b>Fabric Color #</b> | + \$76.00  |
| <input type="radio"/> Grade 4 / Grade-in C                      | <b>Fabric Color #</b> | + \$81.00  |
| <input type="radio"/> Grade 5 / Grade-in D                      | <b>Fabric Color #</b> | + \$86.00  |
| <input type="radio"/> Grade 6 / Grade-in E                      | <b>Fabric Color #</b> | + \$91.00  |
| <input type="radio"/> Evita leather (Black/White/Stone/Vanilla) | <b>Fabric Color #</b> | + \$200.00 |

Color #

## 5. Seat Upholstery Material

\*\*Zodiac Mesh (OM5 Series®) & Neighborhood Collection (Affirm Series) are NOT recommended for use as seat upholstery.

| SEAT UPHOLSTERY   | CODE                  | PRICE      |
|---|-----------------------|------------|
| <input type="radio"/> Grade 1 / C.O.M.                          | <b>Fabric Color #</b> | + \$0      |
| <input type="radio"/> Grade 2 / Grade-in A                      | <b>Fabric Color #</b> | + \$10.00  |
| <input type="radio"/> Grade 3 / Grade-in B                      | <b>Fabric Color #</b> | + \$20.00  |
| <input type="radio"/> Grade 4 / Grade-in C                      | <b>Fabric Color #</b> | + \$30.00  |
| <input type="radio"/> Grade 5 / Grade-in D                      | <b>Fabric Color #</b> | + \$40.00  |
| <input type="radio"/> Grade 6 / Grade-in E                      | <b>Fabric Color #</b> | + \$50.00  |
| <input type="radio"/> Evita Leather (Black/White/Stone/Vanilla) | <b>Fabric Color #</b> | + \$164.00 |

Color #

## 6. Cylinder

| CYLINDER STYLES   | CODE       | PRICE     |
|---|------------|-----------|
| <input type="radio"/> 5" Black                                  | <b>OB5</b> | + \$0     |
| <input type="radio"/> 5" Chrome (Standard on OM5-G)             | <b>OC5</b> | + \$20.00 |
| <input type="radio"/> 8" Chrome (must be ordered with GSP base) | <b>OC8</b> | + \$0     |

## 7. Base

| BASE STYLES  | CODE       | PRICE     |
|--|------------|-----------|
| <input type="radio"/> Black  | <b>B27</b> | + \$0     |
| <input type="radio"/> Polished Aluminum (Standard on OM5-G)                        | <b>P27</b> | + \$68.00 |
| <input type="radio"/> Fixed Height Chrome Footring (default on 8" chrome cylinder) | <b>GSP</b> | + \$55.56 |

## 8. Casters

| CASTER STYLES                      | CODE       | PRICE     |
|------------------------------------|------------|-----------|
| <input type="radio"/> Soft         | <b>SC</b>  | + \$0     |
| <input type="radio"/> Glides       | <b>GLD</b> | + \$0     |
| <input type="radio"/> Rubber       | <b>RUB</b> | + \$25.00 |
| <input type="radio"/> Safety       | <b>SS</b>  | + \$25.00 |
| <input type="radio"/> Rev. Braking | <b>REV</b> | + \$35.00 |

## 9. Other Options

|   | CODE          | PRICE     |
|---|---------------|-----------|
| <input type="radio"/> Memory Foam Sub-layer | <b>UPHCFT</b> | + \$66.00 |



**OM5-GEX Executive High Back**

## OM5ex series® executive chair

### DESCRIPTION

- Tall back
- Regular seat (with waterfall flex feature)
- OM5 series® body-activated motion
- Virtual pause/lock
- Polyflex with variable back resistance

## Specifications

| MODEL          | EXECUTIVE VERSION                              |
|----------------|--|
| Overall width  | 27"  |
| Overall height | 40" - 45"                                      |
| Back           | 18"w - 24.5" h                                 |
| Seat           | 19.75" w x 17-18.5" d<br>(16-17.5" d back uph) |
| Seat height    | 16" - 21"                                      |
| COM            | .75 yd. seat<br>1 yd. back                     |
| Carton weight  | 67 pounds                                      |
| UPS weight     | 195 pounds                                     |
| Arms           | Optional                                       |
| Warranty       | Lifetime Limited                               |
| Weight Rating  | 300 lbs.                                       |

## Order your chair worksheet

| CATEGORY              | CODE | PRICE |
|-----------------------|------|-------|
| 1. Model type / color |      |       |
| 2. Arms               |      |       |
| 3. Poly-Flex Back     |      |       |
| 4. Back Upholstery    |      |       |
| 5. Seat Upholstery    |      |       |
| 6. Cylinder           |      |       |
| 7. Base               |      |       |
| 8. Casters            |      |       |
| 9. Other Options      |      |       |

Unit Price

+ Number of Chairs

= Total Cost for Chairs



## 1. Model

| FRAME COLOR                          | CODE           | PRICE    |
|--------------------------------------|----------------|----------|
| <input type="radio"/> Modern Black   | <b>OM5-BEX</b> | \$718.00 |
| <input type="radio"/> Palladium Grey | <b>OM5-GEX</b> | \$818.00 |



## 2. Arms

| ARMS   | CODE        | PRICE    |
|--|-------------|----------|
| <input type="radio"/> No Arms  | <b>N</b>    | + \$0    |
| <input type="radio"/> With height adjustable OM5 Arms  | <b>A</b>    | + \$98   |
| <input type="radio"/> With ht./width, fore/aft, inward pivot Arms. Code: RP45 multi-adjustable   | <b>RP45</b> | + \$148* |
| <input type="radio"/> With ht./width, fore/aft, pivot Arms Code: RP50 fully-adjustable           | <b>RP50</b> | + \$198* |
| <input type="radio"/> With ht./width, fore/aft, pivot Arms Code: RP65 fully-adjustable, lockable | <b>RP65</b> | + \$208* |

\* List Prices Include OM5 Arm Frame and respective Arm Top

## 3. Poly Flex Back

| POLY FLEX COLOR                      | CODE        | PRICE |
|--------------------------------------|-------------|-------|
| <input type="radio"/> Modern Black   | <b>PBEX</b> | + \$0 |
| <input type="radio"/> Palladium Grey | <b>PGEX</b> | + \$0 |
| <input type="radio"/> Arctic White   | <b>PWEX</b> | + \$0 |

## 4. Back Upholstery Material

| BACK UPHOLSTERY   | CODE                  | PRICE      |
|---|-----------------------|------------|
| <input type="radio"/> Not Upholstered                           | <b>PF</b>             | + \$0      |
| <input type="radio"/> Zodiac Mesh**                             | <b>2300-2310</b>      | + \$38.00  |
| <input type="radio"/> Grade 1 / C.O.M.                          | <b>Fabric Color #</b> | + \$66.00  |
| <input type="radio"/> Grade 2 / Grade-in A                      | <b>Fabric Color #</b> | + \$71.00  |
| <input type="radio"/> Grade 3 / Grade-in B                      | <b>Fabric Color #</b> | + \$76.00  |
| <input type="radio"/> Grade 4 / Grade-in C                      | <b>Fabric Color #</b> | + \$81.00  |
| <input type="radio"/> Grade 5 / Grade-in D                      | <b>Fabric Color #</b> | + \$86.00  |
| <input type="radio"/> Grade 6 / Grade-in E                      | <b>Fabric Color #</b> | + \$91.00  |
| <input type="radio"/> Evita leather (Black/White/Stone/Vanilla) | <b>Fabric Color #</b> | + \$200.00 |
| Color #   |                       |            |

## 5. Seat Upholstery Material

\*\*Zodiac Mesh (OM5 Series®) & Neighborhood Collection (Affirm Series) are NOT recommended for use as seat upholstery.

| SEAT UPHOLSTERY   | CODE                  | PRICE      |
|---|-----------------------|------------|
| <input type="radio"/> Grade 1 / C.O.M.                          | <b>Fabric Color #</b> | + \$0      |
| <input type="radio"/> Grade 2 / Grade-in A                      | <b>Fabric Color #</b> | + \$10.00  |
| <input type="radio"/> Grade 3 / Grade-in B                      | <b>Fabric Color #</b> | + \$20.00  |
| <input type="radio"/> Grade 4 / Grade-in C                      | <b>Fabric Color #</b> | + \$30.00  |
| <input type="radio"/> Grade 5 / Grade-in D                      | <b>Fabric Color #</b> | + \$40.00  |
| <input type="radio"/> Grade 6 / Grade-in E                      | <b>Fabric Color #</b> | + \$50.00  |
| <input type="radio"/> Evita Leather (Black/White/Stone/Vanilla) | <b>Fabric Color #</b> | + \$164.00 |
| Color #   |                       |            |

## 6. Cylinder

| CYLINDER STYLES   | CODE       | PRICE     |
|---|------------|-----------|
| <input type="radio"/> 5" Black                                  | <b>OB5</b> | + \$0     |
| <input type="radio"/> 5" Chrome (Standard on OM5-GEX)           | <b>OC5</b> | + \$20.00 |
| <input type="radio"/> 8" Chrome (must be ordered with GSP base) | <b>OC8</b> | + \$0     |

## 7. Base

| BASE STYLES  | CODE       | PRICE     |
|--|------------|-----------|
| <input type="radio"/> Black  | <b>B27</b> | + \$0     |
| <input type="radio"/> Polished Aluminum (Standard on OM5-GEX)                      | <b>P27</b> | + \$68.00 |
| <input type="radio"/> Fixed Height Chrome Footring (default on 8" chrome cylinder) | <b>GSP</b> | + \$55.56 |

## 8. Casters

| CASTER STYLES                      | CODE       | PRICE     |
|------------------------------------|------------|-----------|
| <input type="radio"/> Soft         | <b>SC</b>  | + \$0     |
| <input type="radio"/> Glides       | <b>GLD</b> | + \$0     |
| <input type="radio"/> Rubber       | <b>RUB</b> | + \$25.00 |
| <input type="radio"/> Safety       | <b>SS</b>  | + \$25.00 |
| <input type="radio"/> Rev. Braking | <b>REV</b> | + \$35.00 |

## 9. Other Options

|   | CODE          | PRICE     |
|---|---------------|-----------|
| <input type="radio"/> Memory Foam Sub-layer | <b>UPHCFT</b> | + \$66.00 |

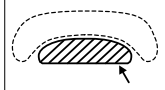



**OM5-GXT Xtra Tall**

## OM5xt series® Xtra tall chair

### DESCRIPTION

- Tall back
- Deep seat
- Xtra Tall 5-star base
- OM5 series® body-activated motion
- Virtual pause/lock
- Polyflex with variable back resistance

## Specifications

| MODEL          | XTRA TALL                            |
|----------------|--------------------------------------|
| Overall width  | 28"                                  |
| Overall height | 40.5" - 45.5"                        |
| Back           | 18" w - 24.5" h                      |
| Seat           | 19.75" w x 21" d<br>(20" d back uph) |
| Seat height    | 19" - 24"                            |
| COM            | 1 yd. seat<br>1 yd. back             |
| Carton weight  | 69 pounds                            |
| UPS weight     | 195 pounds                           |
| Arms           | Optional                             |
| Warranty       | Lifetime Limited                     |
| Weight Rating  | 300 lbs.                             |

## Order your chair worksheet

| CATEGORY              | CODE | PRICE |
|-----------------------|------|-------|
| 1. Model type / color |      |       |
| 2. Arms               |      |       |
| 3. Poly-Flex Back     |      |       |
| 4. Back Upholstery    |      |       |
| 5. Seat Upholstery    |      |       |
| 6. Cylinder           |      |       |
| 7. Base               |      |       |
| 8. Casters            |      |       |
| 9. Other Options      |      |       |

Unit Price

+ Number of Chairs

= Total Cost for Chairs

## 1. Model

| FRAME COLOR                          | CODE           | PRICE    |
|--------------------------------------|----------------|----------|
| <input type="radio"/> Modern Black   | <b>OM5-BXT</b> | \$748.00 |
| <input type="radio"/> Palladium Grey | <b>OM5-GXT</b> | \$860.00 |



## 2. Arms

| ARMS   | CODE        | PRICE    |
|--|-------------|----------|
| <input type="radio"/> No Arms  | <b>N</b>    | + \$0    |
| <input type="radio"/> With height adjustable OM5 Arms  | <b>A</b>    | + \$98   |
| <input type="radio"/> With ht./width, fore/aft, inward pivot Arms. Code: RP45 multi-adjustable   | <b>RP45</b> | + \$148* |
| <input type="radio"/> With ht./width, fore/aft, pivot Arms Code: RP50 fully-adjustable           | <b>RP50</b> | + \$198* |
| <input type="radio"/> With ht./width, fore/aft, pivot Arms Code: RP65 fully-adjustable, lockable | <b>RP65</b> | + \$208* |

\* List Prices Include OM5 Arm Frame and respective Arm Top

## 3. Poly Flex Back

| POLY FLEX COLOR                      | CODE        | PRICE |
|--------------------------------------|-------------|-------|
| <input type="radio"/> Modern Black   | <b>PBXT</b> | + \$0 |
| <input type="radio"/> Palladium Grey | <b>PGXT</b> | + \$0 |
| <input type="radio"/> Arctic White   | <b>PWXT</b> | + \$0 |

## 4. Back Upholstery Material

| BACK UPHOLSTERY   | CODE                  | PRICE      |
|---|-----------------------|------------|
| <input type="radio"/> Not Upholstered                           | <b>PF</b>             | + \$0      |
| <input type="radio"/> Zodiac Mesh**                             | <b>2300-2310</b>      | + \$38.00  |
| <input type="radio"/> Grade 1 / C.O.M.                          | <b>Fabric Color #</b> | + \$66.00  |
| <input type="radio"/> Grade 2 / Grade-in A                      | <b>Fabric Color #</b> | + \$71.00  |
| <input type="radio"/> Grade 3 / Grade-in B                      | <b>Fabric Color #</b> | + \$76.00  |
| <input type="radio"/> Grade 4 / Grade-in C                      | <b>Fabric Color #</b> | + \$81.00  |
| <input type="radio"/> Grade 5 / Grade-in D                      | <b>Fabric Color #</b> | + \$86.00  |
| <input type="radio"/> Grade 6 / Grade-in E                      | <b>Fabric Color #</b> | + \$91.00  |
| <input type="radio"/> Evita leather (Black/White/Stone/Vanilla) | <b>Fabric Color #</b> | + \$200.00 |
| Color #   |                       |            |

## 5. Seat Upholstery Material

\*\*Zodiac Mesh (OM5 Series®) & Neighborhood Collection (Affirm Series) are NOT recommended for use as seat upholstery.

| SEAT UPHOLSTERY   | CODE                  | PRICE      |
|---|-----------------------|------------|
| <input type="radio"/> Grade 1 / C.O.M.                          | <b>Fabric Color #</b> | + \$0      |
| <input type="radio"/> Grade 2 / Grade-in A                      | <b>Fabric Color #</b> | + \$10.00  |
| <input type="radio"/> Grade 3 / Grade-in B                      | <b>Fabric Color #</b> | + \$20.00  |
| <input type="radio"/> Grade 4 / Grade-in C                      | <b>Fabric Color #</b> | + \$30.00  |
| <input type="radio"/> Grade 5 / Grade-in D                      | <b>Fabric Color #</b> | + \$40.00  |
| <input type="radio"/> Grade 6 / Grade-in E                      | <b>Fabric Color #</b> | + \$50.00  |
| <input type="radio"/> Evita Leather (Black/White/Stone/Vanilla) | <b>Fabric Color #</b> | + \$164.00 |
| Color #   |                       |            |

## 6. Cylinder

| CYLINDER STYLES   | CODE       | PRICE     |
|---|------------|-----------|
| <input type="radio"/> 5" Black                                  | <b>OB5</b> | + \$0     |
| <input type="radio"/> 5" Chrome (Standard on OM5-GXT)           | <b>OC5</b> | + \$20.00 |
| <input type="radio"/> 8" Chrome (must be ordered with GSP base) | <b>OC8</b> | + \$0     |

## 7. Base

| BASE STYLES  | CODE       | PRICE     |
|--|------------|-----------|
| <input type="radio"/> Black  | <b>B28</b> | + \$0     |
| <input type="radio"/> Polished Aluminum (Standard on OM5-GXT)                      | <b>P28</b> | + \$68.00 |
| <input type="radio"/> Fixed Height Chrome Footring (default on 8" chrome cylinder) | <b>GSP</b> | + \$55.56 |

## 8. Casters

| CASTER STYLES                      | CODE       | PRICE     |
|------------------------------------|------------|-----------|
| <input type="radio"/> Soft         | <b>SC</b>  | + \$0     |
| <input type="radio"/> Glides       | <b>GLD</b> | + \$0     |
| <input type="radio"/> Rubber       | <b>RUB</b> | + \$25.00 |
| <input type="radio"/> Safety       | <b>SS</b>  | + \$25.00 |
| <input type="radio"/> Rev. Braking | <b>REV</b> | + \$35.00 |

## 9. Other Options

|   | CODE          | PRICE     |
|---|---------------|-----------|
| <input type="radio"/> Memory Foam Sub-layer | <b>UPHCFT</b> | + \$66.00 |

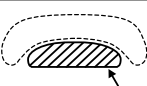



## features:

Begins @ \$580 armless (9100) and \$653 with fixed loop arms (9101)

A traditional chair intended for conference and executive environments

One-piece seat and back that is simple and easy to maintain



### 9101S

Pictured here with fixed loop arms  
and Grade 3 Stage Aida upholstery  
\$470.00 List (as shown)



### 9100S

Pictured here with Grade 3 Stage Fame  
\$397.00 List (as shown)

→  
Use our  
handy  
stickers to  
mark this  
section.

pacific series  
(9xxx)

# pacific series

conference | boardroom | executive

average / medium

## Model

9100



300 POUNDS CAPACITY

## Description

Pneumatic lift  
Full knee tilt  
Tilt lock  
Tension knob  
Fabric panel back

## Textile Grade-In

Grade 1 / C.O.M. \$580.00  
Grade 2 \$605.00  
Grade 3 / Grade-in A \$630.00  
Grade 4 / Grade-in B \$655.00  
Grade-in C \$680.00  
Grade-in D \$705.00

## List

## Specifications

Overall width 27"  
Overall height 38" - 43"  
Back 20" w x 19" h  
Seat 20" w x 19" d  
Seat height 18" - 23"  
COM 2 yds.  
Carton weight 48 pounds  
UPS weight 101 pounds  
Arms See model 9101  
Warranty 12 year limited

## Model

9101



300 POUNDS CAPACITY

## Description

Pneumatic lift  
Full knee tilt  
Tilt lock  
Tension knob  
Fabric panel back  
Fixed loop arms standard

## Textile Grade-In

Grade 1 / C.O.M. \$653.00  
Grade 2 \$678.00  
Grade 3 / Grade-in A \$703.00  
Grade 4 / Grade-in B \$728.00  
Grade-in C \$753.00  
Grade-in D \$778.00

## List

## Specifications

Overall width 27"  
Overall height 38" - 43"  
Back 20" w x 19" h  
Seat 20" w x 19" d  
Seat height 18" - 23"  
COM 2 yds.  
Carton weight 55 pounds  
UPS weight 101 pounds  
Arms Included  
Warranty 12 year limited

large / xtra tall

## Model

9200



300 POUNDS CAPACITY

## Description

Pneumatic lift  
Full knee tilt  
Tilt lock  
Tension knob  
Fabric panel back  
Fixed loop arms standard

## Textile Grade-In

Grade 1 / C.O.M. \$725.00  
Grade 2 \$750.00  
Grade 3 / Grade-in A \$775.00  
Grade 4 / Grade-in B \$800.00  
Grade-in C \$825.00  
Grade-in D \$850.00

## List

## Specifications

Overall width 27"  
Overall height 43" - 48"  
Back 20" w x 27" h  
Seat 20" w x 19" d  
Seat height 18" - 23"  
COM 2 yds.  
Carton weight 58 pounds  
UPS weight 101 pounds  
Arms Included  
Warranty 12 year limited

side chairs

**Model**

9100S



300  
POUNDS  
CAPACITY

**Description**

Sled base  
Fabric panel back

**Textile Grade-In**

|                      |          |
|----------------------|----------|
| Grade 1 / C.O.M.     | \$347.00 |
| Grade 2              | \$372.00 |
| Grade 3 / Grade-in A | \$397.00 |
| Grade 4 / Grade-in B | \$422.00 |
| Grade-in C           | \$447.00 |
| Grade-in D           | \$472.00 |

**List**

**Specifications**

|                |                 |
|----------------|-----------------|
| Overall width  | 21"             |
| Overall height | 37"             |
| Back           | 20" w x 19" h   |
| Seat           | 20" w x 19" d   |
| Seat height    | 18"             |
| COM            | 2 yds.          |
| Carton weight  | 36 pounds       |
| UPS weight     | 100 pounds      |
| Arms           | See model 9101S |
| Warranty       | 12 year limited |

**Model**

9101S



300  
POUNDS  
CAPACITY

**Description**

Sled base  
Fabric panel back  
Fixed loop arms standard

**Textile Grade-In**

|                      |          |
|----------------------|----------|
| Grade 1 / C.O.M.     | \$420.00 |
| Grade 2              | \$445.00 |
| Grade 3 / Grade-in A | \$470.00 |
| Grade 4 / Grade-in B | \$495.00 |
| Grade-in C           | \$520.00 |
| Grade-in D           | \$545.00 |

**List**

**Specifications**

|                |                 |
|----------------|-----------------|
| Overall width  | 25"             |
| Overall height | 37"             |
| Back           | 20" w x 19" h   |
| Seat           | 20" w x 19" d   |
| Seat height    | 18"             |
| COM            | 2 yds.          |
| Carton weight  | 42 pounds       |
| UPS weight     | 100 pounds      |
| Arms           | Included        |
| Warranty       | 12 year limited |





features:

Begins @ \$487 armless / \$596 with KR-200 arms (PT62)

PTxx – Value-oriented and fully loaded ergonomic series

7xxx – A more executive look (upholstered outer backshells and executive styling)

Timeless design allows for this long-lasting series to stay current no matter the environment

Wide range of size options within the series to fit any user “big” to “small”

Most models standard with adjustable lumbar, seat depth & independently adjustable back/seat



**PT76S**  
Value Series



**PT78**  
Pictured here with optional  
Grade 5 Comfort Knit Monarch upholstery  
\$675.00 List (as shown)

→  
Use our  
handy  
stickers to  
mark this  
section.  
paramount  
(PT / 7xxx)

# paramount series (PT)

value line | general office

Please see pages 71, 138 -149 for arm kits, casters, and other options.

small / petite

| Model | Description               | Value Line | Textile Grade-In            | List     | Specifications               |
|-------|---------------------------|------------|-----------------------------|----------|------------------------------|
| PT62  | Pneumatic lift            |            | Grade 1 / C.O.M.            | \$487.00 | Overall width 25"            |
|       | Tilting backrest          |            | Grade 2 / Grade-in A        | \$507.00 | Overall height 32.5" - 38.5" |
|       | EZ back height adjustment |            | Grade 3 / Grade-in B        | \$527.00 | Back 17" w x 16" h           |
|       | Rocking tilt              |            | Grade 4 / Grade-in C        | \$547.00 | Seat 19" w x 16-19.1" d      |
|       | Seat tilting              |            | Grade 5 / Grade-in D        | \$567.00 | Seat height 15.5" - 19.5"    |
|       | Seat depth adjustment     |            | Grade 6 / Grade-in E        | \$587.00 | COM 1 yd.                    |
|       | Forward tilting           |            | Evita leather               |          | Carton weight 54 pounds      |
|       | Tension knob              |            | (Black/White/Stone/Vanilla) | \$712.00 | UPS weight 101 pounds        |
|       | Extra-low cylinder        |            |                             |          | Arms Groups 1 & 4            |
|       |                           |            |                             |          | Warranty 12 year limited     |
|       |                           |            |                             |          |                              |



| Model | Description               | Value Line | Textile Grade-In            | List     | Specifications            |
|-------|---------------------------|------------|-----------------------------|----------|---------------------------|
| PT69  | Pneumatic lift            |            | Grade 1 / C.O.M.            | \$543.00 | Overall width 25"         |
|       | Tilting backrest          |            | Grade 2 / Grade-in A        | \$563.00 | Overall height 40" - 49"  |
|       | EZ back height adjustment |            | Grade 3 / Grade-in B        | \$583.00 | Back 17" w x 22" h        |
|       | Rocking tilt              |            | Grade 4 / Grade-in C        | \$603.00 | Seat 19" w x 15.5-18.6" d |
|       | Seat tilting              |            | Grade 5 / Grade-in D        | \$623.00 | Seat height 17" - 22"     |
|       | Seat depth adjustment     |            | Grade 6 / Grade-in E        | \$643.00 | COM 1 yd.                 |
|       | Adjustable lumbar         |            | Evita leather               |          | Carton weight 58 pounds   |
|       | Forward tilting           |            | (Black/White/Stone/Vanilla) | \$768.00 | UPS weight 101 pounds     |
|       | Tension knob              |            |                             |          | Arms Groups 1 & 4         |
|       |                           |            |                             |          | Warranty 12 year limited  |
|       |                           |            |                             |          |                           |



# paramount series (PT)

Please see pages 71, 138 - 149 for arm kits, casters, and other options.

average / medium

| Model | Description               | Value Line | Textile Grade-In            | List     | Specifications           |
|-------|---------------------------|------------|-----------------------------|----------|--------------------------|
| PT72N | Pneumatic lift            |            | Grade 1 / C.O.M.            | \$460.00 | Overall width 27"        |
|       | Tilting backrest          |            | Grade 2 / Grade-in A        | \$480.00 | Overall height 35" - 44" |
|       | EZ back height adjustment |            | Grade 3 / Grade-in B        | \$500.00 | Back 17" w x 18" h       |
|       | Rocking tilt              |            | Grade 4 / Grade-in C        | \$520.00 | Seat 20" w x 17-20.1" d  |
|       | Seat tilting              |            | Grade 5 / Grade-in D        | \$540.00 | Seat height 17" - 22"    |
|       | Seat depth adjustment     |            | Grade 6 / Grade-in E        | \$560.00 | COM 1 yd.                |
|       | Infinite forward tilting  |            | Evita leather               |          | Carton weight 45 pounds  |
|       | Tension knob              |            | (Black/White/Stone/Vanilla) | \$710.00 | UPS weight 101 pounds    |
|       |                           |            |                             |          | Arms Groups 1 & 4        |
|       |                           |            |                             |          | Warranty 12 year limited |

| Model | Description               | Value Line | Textile Grade-In            | List     | Specifications           |
|-------|---------------------------|------------|-----------------------------|----------|--------------------------|
| PT74  | Pneumatic lift            |            | Grade 1 / C.O.M.            | \$538.00 | Overall width 27"        |
|       | Tilting backrest          |            | Grade 2 / Grade-in A        | \$558.00 | Overall height 35" - 44" |
|       | EZ back height adjustment |            | Grade 3 / Grade-in B        | \$578.00 | Back 17" w x 18" h       |
|       | Rocking tilt              |            | Grade 4 / Grade-in C        | \$598.00 | Seat 20" w x 17-20.1" d  |
|       | Seat tilting              |            | Grade 5 / Grade-in D        | \$618.00 | Seat height 17" - 22"    |
|       | Seat depth adjustment     |            | Grade 6 / Grade-in E        | \$638.00 | COM 1 yd.                |
|       | Adjustable lumbar         |            | Evita leather               |          | Carton weight 53 pounds  |
|       | Forward tilting           |            | (Black/White/Stone/Vanilla) | \$788.00 | UPS weight 101 pounds    |
|       | Tension knob              |            |                             |          | Arms Groups 1 & 4        |
|       |                           |            |                             |          | Warranty 12 year limited |



300 POUNDS CAPACITY



300 POUNDS CAPACITY

# paramount series (PT)

value line | general office

Please see pages 71, 138 -149 for arm kits, casters, and other options.

large / xtra tall

## Model

PT76N



300  
POUNDS  
CAPACITY

## Description

Pneumatic lift  
Tilting backrest  
EZ back height adjustment  
Rocking tilt  
Seat tilting  
Seat depth adjustment  
Infinite forward tilting  
Tension knob

## Textile Grade-In

Grade 1 / C.O.M. \$511.00  
Grade 2 / Grade-in A \$531.00  
Grade 3 / Grade-in B \$551.00  
Grade 4 / Grade-in C \$571.00  
Grade 5 / Grade-in D \$591.00  
Grade 6 / Grade-in E \$611.00  
Evita leather  
(Black/White/Stone/Vanilla) \$761.00

## List

## Specifications

Overall width 27"  
Overall height 37.5" - 46.5"  
Back 19.5" w x 22" h  
Seat 21" w x 18-21.1" d  
Seat height 17" - 22"  
COM 1.5 yds.  
Carton weight 50 pounds  
UPS weight 101 pounds  
Arms Groups 1 & 4  
Warranty 12 year limited

## Model

PT78



300  
POUNDS  
CAPACITY

## Description

Pneumatic lift  
Tilting backrest  
EZ back height adjustment  
Rocking tilt  
Seat tilting  
Seat depth adjustment  
Adjustable lumbar  
Forward tilting  
Tension knob

## Textile Grade-In

Grade 1 / C.O.M. \$595.00  
Grade 2 / Grade-in A \$615.00  
Grade 3 / Grade-in B \$635.00  
Grade 4 / Grade-in C \$655.00  
Grade 5 / Grade-in D \$675.00  
Grade 6 / Grade-in E \$695.00  
Evita leather  
(Black/White/Stone/Vanilla) \$845.00

## List

## Specifications

Overall width 27"  
Overall height 40" - 48"  
Back 19.5" w x 22" h  
Seat 21" w x 18-21.1" d  
Seat height 17" - 22"  
COM 1.5 yds.  
Carton weight 57 pounds  
UPS weight 101 pounds  
Arms Groups 1 & 4  
Warranty 12 year limited

## Model

PT79



UPS  
oversize

300  
POUNDS  
CAPACITY

## Description

Pneumatic lift  
Tilting backrest  
EZ back height adjustment  
Rocking tilt  
Seat tilting  
Seat depth adjustment  
Adjustable lumbar  
Forward tilting  
Tension knob

## Textile Grade-In

Grade 1 / C.O.M. \$648.00  
Grade 2 / Grade-in A \$668.00  
Grade 3 / Grade-in B \$688.00  
Grade 4 / Grade-in C \$708.00  
Grade 5 / Grade-in D \$728.00  
Grade 6 / Grade-in E \$748.00  
Evita leather  
(Black/White/Stone/Vanilla) \$898.00

## List

## Specifications

Overall width 27"  
Overall height 46" - 55"  
Back 19.5" w x 28" h  
Seat 21" w x 18-21.1" d  
Seat height 17" - 22"  
COM 1.5 yds.  
Carton weight 63 pounds  
UPS weight 195 pounds  
Arms Groups 1 & 4  
Warranty 12 year limited

# paramount series (PT)

Please see pages 71, 138 - 149 for arm kits, casters, and other options.

large / xtra tall

| Model  | Description               | Textile Grade-In                       | List     | Specifications              |
|--|---------------------------|--|----------|-----------------------------|
| <b>PTYM</b><br> <p>ups<br/>oversize<br/>300<br/>POUNDS<br/>CAPACITY</p> | Pneumatic lift            | Grade 1 / C.O.M.                       | \$890.00 | Overall width 28"           |
|  | Tilting backrest          | Grade 2 / Grade-in A                   | \$910.00 | Overall height 41" - 51"    |
|  | EZ back height adjustment | Grade 3 / Grade-in B                   | \$930.00 | Back 19.5" w x 22" h        |
|  | Rocking tilt              | Grade 4 / Grade-in C                   | \$950.00 | Seat 23.5" w x 21.5-24.6" d |
|  | Seat tilting              | Grade 5 / Grade-in D                   | \$970.00 | Seat height 19" - 25"       |
|  | Seat depth adjustment     | Grade 6 / Grade-in E                   | \$990.00 | COM 1.5 yds.                |
|  | Adjustable lumbar         | Evita leather                          |          | Carton weight 60 pounds     |
|  | Forward tilting           | (Black/White/Stone/Vanilla) \$1,140.00 |          | UPS weight 195 pounds       |
|  | Tension knob              |  |          | Arms Groups 1 & 4           |
|  | Memory foam in seat       |  |          | Warranty 12 year limited    |
|  | Dual-tone casters         |  |          |                             |

| Model   | Description                         | Textile Grade-In                       | List       | Specifications              |
|---|-------------------------------------|--|------------|-----------------------------|
| <b>PTYM-xt</b><br> <p>ups<br/>oversize<br/>300<br/>POUNDS<br/>CAPACITY</p> | Pneumatic lift                      | Grade 1 / C.O.M.                       | \$941.00   | Overall width 28"           |
|   | <b>Tilting backrest (PT79 size)</b> | Grade 2 / Grade-in A                   | \$961.00   | Overall height 47" - 58"    |
|   | EZ back height adjustment           | Grade 3 / Grade-in B                   | \$981.00   | Back 19.5" w x 28" h        |
|   | Rocking tilt                        | Grade 4 / Grade-in C                   | \$1,001.00 | Seat 23.5" w x 21.5-24.6" d |
|   | Seat tilting                        | Grade 5 / Grade-in D                   | \$1,021.00 | Seat height 19" - 25"       |
|   | Seat depth adjustment               | Grade 6 / Grade-in E                   | \$1,041.00 | COM 1.5 yds.                |
|   | Adjustable lumbar                   | Evita leather                          |            | Carton weight 66 pounds     |
|   | Forward tilting                     | (Black/White/Stone/Vanilla) \$1,191.00 |            | UPS weight 195 pounds       |
|   | Tension knob                        |  |            | Arms Groups 1 & 4           |
|   | Memory foam in seat                 |  |            | Warranty 12 year limited    |
|   | Dual-tone casters                   |  |            |                             |

# paramount series (PT)

value line | general office

Please see page 149 for some relevant options.

side chairs / nesting

| Model | Description                     | Value Line | Textile Grade-In            | List                     | Specifications          |
|-------|---------------------------------|------------|-----------------------------|--------------------------|-------------------------|
| PT70N | Convenient nesting chair design |            | Grade 1 / C.O.M.            | \$353.00                 | Overall width 24.5"     |
|       | Upholstered backrest            |            | Grade 2 / Grade-in A        | \$373.00                 | Overall height 39"      |
|       | Fixed arms standard             |            | Grade 3 / Grade-in B        | \$393.00                 | Back 17" w x 18" h      |
|       |                                 |            | Grade 4 / Grade-in C        | \$413.00                 | Seat 18" w x 18" d      |
|       |                                 |            | Grade 5 / Grade-in D        | \$433.00                 | Seat height 18"         |
|       |                                 |            | Grade 6 / Grade-in E        | \$453.00                 | COM 1 yd.               |
|       |                                 |            | Evita leather               |                          | Carton weight 40 pounds |
|       |                                 |            | (Black/White/Stone/Vanilla) | \$578.00                 | UPS weight 85 pounds    |
|       |                                 |            |                             | Arms Included            |                         |
|       |                                 |            |                             | Warranty 12 year limited |                         |



| Model | Description | Value Line | Textile Grade-In            | List                     | Specifications          |
|-------|-------------|------------|-----------------------------|--------------------------|-------------------------|
| PT74S | Sled base   |            | Grade 1 / C.O.M.            | \$269.00                 | Overall width 20"       |
|       | Armless     |            | Grade 2 / Grade-in A        | \$289.00                 | Overall height 38"      |
|       |             |            | Grade 3 / Grade-in B        | \$309.00                 | Back 17" w x 18" h      |
|       |             |            | Grade 4 / Grade-in C        | \$329.00                 | Seat 19" w x 19" d      |
|       |             |            | Grade 5 / Grade-in D        | \$349.00                 | Seat height 18"         |
|       |             |            | Grade 6 / Grade-in E        | \$369.00                 | COM 1 yd.               |
|       |             |            | Evita leather               |                          | Carton weight 35 pounds |
|       |             |            | (Black/White/Stone/Vanilla) | \$519.00                 | UPS weight 68 pounds    |
|       |             |            |                             | Arms Groups 1 & 4        |                         |
|       |             |            |                             | Warranty 12 year limited |                         |



| Model | Description | Value Line | Textile Grade-In            | List                     | Specifications          |
|-------|-------------|------------|-----------------------------|--------------------------|-------------------------|
| PT76S | Sled base   |            | Grade 1 / C.O.M.            | \$256.00                 | Overall width 24"       |
|       | Armless     |            | Grade 2 / Grade-in A        | \$276.00                 | Overall height 41"      |
|       |             |            | Grade 3 / Grade-in B        | \$296.00                 | Back 19" w x 21" h      |
|       |             |            | Grade 4 / Grade-in C        | \$316.00                 | Seat 20" w x 20" d      |
|       |             |            | Grade 5 / Grade-in D        | \$336.00                 | Seat height 18"         |
|       |             |            | Grade 6 / Grade-in E        | \$356.00                 | COM 1.5 yds.            |
|       |             |            | Evita leather               |                          | Carton weight 41 pounds |
|       |             |            | (Black/White/Stone/Vanilla) | \$506.00                 | UPS weight 100 pounds   |
|       |             |            |                             | Arms Groups 1 & 4        |                         |
|       |             |            |                             | Warranty 12 year limited |                         |



| Model | Description               | Value Line | Textile Grade-In            | List                     | Specifications          |
|-------|---------------------------|------------|-----------------------------|--------------------------|-------------------------|
| PT78S | Sled base                 |            | Grade 1 / C.O.M.            | \$295.00                 | Overall width 24"       |
|       | Standard closed loop arms |            | Grade 2 / Grade-in A        | \$315.00                 | Overall height 41"      |
|       |                           |            | Grade 3 / Grade-in B        | \$335.00                 | Back 19" w x 21" h      |
|       |                           |            | Grade 4 / Grade-in C        | \$355.00                 | Seat 20" w x 20" d      |
|       |                           |            | Grade 5 / Grade-in D        | \$375.00                 | Seat height 18"         |
|       |                           |            | Grade 6 / Grade-in E        | \$395.00                 | COM 1.5 yds.            |
|       |                           |            | Evita leather               |                          | Carton weight 41 pounds |
|       |                           |            | (Black/White/Stone/Vanilla) | \$545.00                 | UPS weight 100 pounds   |
|       |                           |            |                             | Arms Included            |                         |
|       |                           |            |                             | Warranty 12 year limited |                         |







omsmartsitting.com

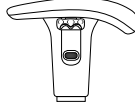

common options

### Suggested Options for Paramount Series (PT)

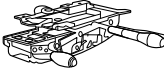
|   |   |
|---|---|
| <p><b>Arms kits</b></p>  <p><b>KR-200</b> - list: 109.00<br/>Height and width adjustable and removable T-arms with natural grip control. Adjustable height range of 2.75". Adjustable width range of approximately 1.25" per side. 12 year limited warranty on arm frames &amp; 2 year limited warranty on arm pads*</p> |  <p><b>JR-69</b> - list: 206.00<br/>2-way adjustable (W/H) forward-slanting T-arms with RP65 lockable arm pads. Black only<br/>Adjustable height range of 4.25". Adjustable width range of 1.75". 7 year limited warranty on arm frames &amp; 2 year on arm pads* (Does not retrofit)</p>  |
|  <p><b>KR-300</b> - list: 134.00<br/>Tallest height, width-adjustable T-arms with waterfall front and contoured arm pads. Adjustable width range of approximately 1.25" per side. 12 year limited warranty on arm frames &amp; 2 year limited warranty on arm pads*</p>  |  <p><b>KR-25</b> - list: 79.00<br/>Contoured height adjustable T-arms featuring natural grip control. Adjustable height range of 2.75". 12 year limited warranty on arm frames &amp; 2 year limited warranty on arm pads*</p>  |
|  <p><b>KR-445</b> - list: 175.00<br/>Height and width adjustable T-arms with smooth fore-aft, side-to-side, and pivoting motion arm caps. Adjustable width range of approximately 1.25" per side. 12 year limited warranty on arm frames &amp; 2 year limited warranty on arm pads*</p>                                  |  <p><b>-RV</b> - list: 30.00 upcharge<br/>Executive synchronized mechanism with 5-position recline lockouts and an independent back angle adjustment. Also features a side-mounted tension knob (option for: PT69, PT74, PT78, PT79, PTYM).<br/>Note: Changing to an -RV option decreases seat depth by -0.6" (2.5" depth range).</p> |

# paramount series (7xxx)

general office

Please see pages 73, 138 -149 for arm kits, casters, and other options.

average / medium

| Model  | Description               | Textile Grade-In            | List     | Specifications            |
|--|---------------------------|-----------------------------|----------|---------------------------|
|  <p>7770</p> <p>300 POUNDS CAPACITY</p> | Pneumatic lift            | Grade 1 / C.O.M.            | \$538.00 | Overall width 27"         |
|  | EZ back height adjustment | Grade 2 / Grade-in A        | \$558.00 | Overall height 39" - 48"  |
|  | Tilting backrest          | Grade 3 / Grade-in B        | \$578.00 | Back 18" w x 21" h        |
|  | Tilting seat              | Grade 4 / Grade-in C        | \$598.00 | Seat 20" w x 17.5-20.6" d |
|  | Seat depth adjustment     | Grade 5 / Grade-in D        | \$618.00 | Seat height 17" - 22"     |
|  | Swivel/rocking tilt       | Grade 6 / Grade-in E        | \$638.00 | COM 1.5 yds.              |
|  | Tension knob              | Evita leather               |          | Carton weight 45 pounds   |
|  | Fabric panel back         | (Black/White/Stone/Vanilla) | \$788.00 | UPS weight 101 pounds     |
|  | Tilt lock at any angle    |                             |          | Arms Groups 1 & 4         |
|  |                           |                             |          | Warranty 12 year limited  |

| Model  | Description               | Textile Grade-In            | List     | Specifications            |
|--|---------------------------|-----------------------------|----------|---------------------------|
|  <p>7780</p> <p>300 POUNDS CAPACITY</p> | Pneumatic lift            | Grade 1 / C.O.M.            | \$595.00 | Overall width 27"         |
|  | EZ back height adjustment | Grade 2 / Grade-in A        | \$615.00 | Overall height 39" - 48"  |
|  | Tilting backrest          | Grade 3 / Grade-in B        | \$635.00 | Back 18" w x 21" h        |
|  | Tilting seat              | Grade 4 / Grade-in C        | \$655.00 | Seat 20" w x 17.5-20.6" d |
|  | Seat depth adjustment     | Grade 5 / Grade-in D        | \$675.00 | Seat height 17" - 22"     |
|  | Swivel/rocking tilt       | Grade 6 / Grade-in E        | \$695.00 | COM 1.5 yds.              |
|  | Tension knob              | Evita leather               |          | Carton weight 48 pounds   |
|  | Fabric panel back         | (Black/White/Stone/Vanilla) | \$845.00 | UPS weight 101 pounds     |
|  | Tilt lock at any angle    |                             |          | Arms Groups 1 & 4         |
|  | Adjustable lumbar         |                             |          | Warranty 12 year limited  |



general office

# paramount series (7xxx)

Please see pages 138 - 149 for arm kits, casters, and other options.

large / xtra tall

**Model**

7878



300 POUNDS CAPACITY

**Description**

|                           |
|---------------------------|
| Pneumatic lift            |
| EZ back height adjustment |
| Tilting backrest          |
| Tilting seat              |
| Seat depth adjustment     |
| Adjustable lumbar         |
| Swivel/rocking tilt       |
| Tilt lock at any angle    |
| Tension knob              |
| DCS seat                  |

DCS TECHNOLOGY

**Textile Grade-In**

|  |          |
|--|----------|
| Grade 1 / C.O.M.                             | \$683.00 |
| Grade 2 / Grade-in A                         | \$703.00 |
| Grade 3 / Grade-in B                         | \$723.00 |
| Grade 4 / Grade-in C                         | \$743.00 |
| Grade 5 / Grade-in D                         | \$763.00 |
| Grade 6 / Grade-in E                         | \$783.00 |
| Evita leather<br>(Black/White/Stone/Vanilla) | \$933.00 |

**List**

**Specifications**

|                |                    |
|----------------|--------------------|
| Overall width  | 27"                |
| Overall height | 40" - 49"          |
| Back           | 18" w x 23" h      |
| Seat           | 21" w x 18-21.1" d |
| Seat height    | 17" - 22"          |
| COM            | 1.5 yds.           |
| Carton weight  | 55 pounds          |
| UPS weight     | 101 pounds         |
| Arms           | Groups 1 & 4       |
| Warranty       | 12 year limited    |

**Model**

7893



300 POUNDS CAPACITY

**Description**

|                           |
|---------------------------|
| Pneumatic lift            |
| EZ back height adjustment |
| Tilting backrest          |
| Tilting seat              |
| Seat depth adjustment     |
| Tilt lock at any angle    |
| Fabric panel back         |
| Forward tilting           |
| Tension knob              |

**Textile Grade-In**

|  |          |
|--|----------|
| Grade 1 / C.O.M.                             | \$595.00 |
| Grade 2 / Grade-in A                         | \$615.00 |
| Grade 3 / Grade-in B                         | \$635.00 |
| Grade 4 / Grade-in C                         | \$655.00 |
| Grade 5 / Grade-in D                         | \$675.00 |
| Grade 6 / Grade-in E                         | \$695.00 |
| Evita leather<br>(Black/White/Stone/Vanilla) | \$845.00 |

**List**

**Specifications**

|                |                    |
|----------------|--------------------|
| Overall width  | 27"                |
| Overall height | 38" - 47"          |
| Back           | 20" w x 26" h      |
| Seat           | 20.5" w x 18-20" d |
| Seat height    | 17" - 22"          |
| COM            | 2 yds.             |
| Carton weight  | 54 pounds          |
| UPS weight     | 101 pounds         |
| Arms           | Groups 1 & 4       |
| Warranty       | 12 year limited    |

**Model**

7897



300 POUNDS CAPACITY

**Description**

|                           |
|---------------------------|
| Pneumatic lift            |
| EZ back height adjustment |
| Tilting backrest          |
| Tilting seat              |
| 3-way adjustable headrest |
| Forward tilting           |
| Tilt lock at any angle    |
| Fabric panel back         |
| Tension knob              |
| Seat depth adjustment     |

**Textile Grade-In**

|  |          |
|--|----------|
| Grade 1 / C.O.M.                             | \$652.00 |
| Grade 2 / Grade-in A                         | \$672.00 |
| Grade 3 / Grade-in B                         | \$692.00 |
| Grade 4 / Grade-in C                         | \$712.00 |
| Grade 5 / Grade-in D                         | \$732.00 |
| Grade 6 / Grade-in E                         | \$752.00 |
| Evita leather<br>(Black/White/Stone/Vanilla) | \$902.00 |

**List**

**Specifications**

|                |                    |
|----------------|--------------------|
| Overall width  | 27"                |
| Overall height | 38" - 56"          |
| Back           | 20" w x 26" h      |
| Seat           | 20.5" w x 18-20" d |
| Seat height    | 17" - 22"          |
| COM            | 2 yds.             |
| Carton weight  | 59 pounds          |
| UPS weight     | 101 pounds         |
| Arms           | Groups 1 & 4       |
| Warranty       | 12 year limited    |

common options

**Suggested Options for Paramount Series**

**Arms kits**



**JR-39M** - list: 154.00  
2-way adjustable width/height and removable Forward-slanting T-arms with memosoft arm pads and natural grip control. Black only. Adjustable height range of 4.25". Adjustable width range of 1.75" each side. 7 year limited warranty on arm frames & 2 year on arm pads\*

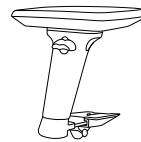

**JR-49** - list: 186.00  
2-way adjustable (W/H) forward-slanting T-arms with RP45 arm pads. Black only. Adjustable height range of 4.25". Adjustable width range of 1.75". 7 year limited warranty on arm frames & 2 year limited warranty on arm pads\*



**KR-445** - list: 175.00  
Height and width adjustable T-arms with smooth fore-aft, side-to-side, and pivoting motion arm caps. Adjustable width range of approximately 1.25" per side. 12 year limited warranty on arm frames & 2 year limited warranty on arm pads\*

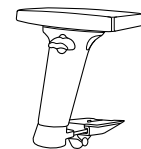

**JR-69** - list: 206.00  
2-way adjustable (W/H) forward-slanting T-arms with RP65 lockable arm pads. Black only. Adjustable height range of 4.25". Adjustable width range of 1.75". 7 year limited warranty on arm frames & 2 year limited warranty on arm pads\*

onmartsseating.com

SMART SEATING





## features:

Begins @ \$359 armless / \$468 with KR-200 arms (PA53)

PA5x, -6x – Popular, simple task chairs good for anyplace that work could happen!

PC5x – Full-featured office and work chairs with a full range of ergonomic adjustments

Wide range of size options within the series to fit any user “big” to “small”



### **PC Series**

Multiple independent adjustments with clean comfortable design. Series starts a \$417.00 List



### **PA Series**

Simple adjustments with clean comfortable design. Series starts a \$264.00 List

→  
Use our  
handy  
stickers to  
mark this  
section.

patriot series  
(PA & PC)

# patriot series (PA)

value line | general office

Please see pages 79, 138 -149 for arm kits, casters, and other options.

small / petite

## Model

PA53



## Description

|                           |            |
|---------------------------|------------|
| Pneumatic lift            | Value Line |
| Tilting backrest          |            |
| EZ back height adjustment |            |
| Seat tilting              |            |
| Seat depth adjustment     |            |

## Textile Grade-In

|  |          |
|--|----------|
| Grade 1 / C.O.M.                             | \$359.00 |
| Grade 2 / Grade-in A                         | \$374.00 |
| Grade 3 / Grade-in B                         | \$389.00 |
| Grade 4 / Grade-in C                         | \$404.00 |
| Grade 5 / Grade-in D                         | \$419.00 |
| Grade 6 / Grade-in E                         | \$434.00 |
| Evita leather<br>(Black/White/Stone/Vanilla) | \$559.00 |

## List

## Specifications

|                |                    |
|----------------|--------------------|
| Overall width  | 25"                |
| Overall height | 32" - 40"          |
| Back           | 17.5" w x 16.5" h  |
| Seat           | 19" w x 17-20.1" d |
| Seat height    | 16" - 21"          |
| COM            | 1 yd.              |
| Carton weight  | 54 pounds          |
| UPS weight     | 101 pounds         |
| Arms           | Groups 1 & 4       |
| Warranty       | 12 year limited    |

## Model [NEW]

PA63



## Description

|                                   |            |
|-----------------------------------|------------|
| Pneumatic lift                    | Value Line |
| EZ back height adjustment         |            |
| 3-stage locking tilt              |            |
| Free-float rocking tilt           |            |
| <b>Synchronous seat/back tilt</b> |            |
| Sliding seat                      |            |
| Tension knob                      |            |

## Textile Grade-In

|  |          |
|--|----------|
| Grade 1 / C.O.M.                             | \$409.00 |
| Grade 2 / Grade-in A                         | \$424.00 |
| Grade 3 / Grade-in B                         | \$439.00 |
| Grade 4 / Grade-in C                         | \$454.00 |
| Grade 5 / Grade-in D                         | \$469.00 |
| Grade 6 / Grade-in E                         | \$484.00 |
| Evita leather<br>(Black/White/Stone/Vanilla) | \$609.00 |

## List

## Specifications

|                |                    |
|----------------|--------------------|
| Overall width  | 25"                |
| Overall height | 32" - 40"          |
| Back           | 17.5" w x 16.5" h  |
| Seat           | 19" w x 17-20.1" d |
| Seat height    | 16" - 21"          |
| COM            | 1 yd.              |
| Carton weight  | 54 pounds          |
| UPS weight     | 101 pounds         |
| Arms           | Groups 1 & 4       |
| Warranty       | 12 year limited    |

Please see pages 79, 138 - 149 for arm kits, casters, and other options.

average / medium

| Model | Description               | Value Line | Textile Grade-In                             | List     | Specifications  |
|-------|---------------------------|------------|--|----------|---|
| PA55  | Pneumatic lift            |            | Grade 1 / C.O.M.                             | \$406.00 | Overall width 27"   |
|       | Tilting backrest          |            | Grade 2 / Grade-in A                         | \$421.00 | Overall height 38" - 46"  |
|       | EZ back height adjustment |            | Grade 3 / Grade-in B                         | \$436.00 | Back 20" w x 21" h  |
|       | Seat tilting              |            | Grade 4 / Grade-in C                         | \$451.00 | Seat 20.5" w x 18-21.1" d   |
|       | Seat depth adjustment     |            | Grade 5 / Grade-in D                         | \$466.00 | Seat height 16.5" - 21.5"   |
|       |                           |            | Grade 6 / Grade-in E                         | \$481.00 | COM 1 yd.   |
|       |                           |            | Evita leather<br>(Black/White/Stone/Vanilla) | \$606.00 | Carton weight 52 pounds<br>UPS weight 101 pounds<br>Arms Groups 1 & 4<br>Warranty 12 year limited |



| Model [NEW] | Description                       | Textile Grade-In                             | List     | Specifications  |
|-------------|-----------------------------------|--|----------|---|
| PA66        | Pneumatic lift                    | Grade 1 / C.O.M.                             | \$456.00 | Overall width 27"   |
|             | EZ back height adjustment         | Grade 2 / Grade-in A                         | \$471.00 | Overall height 38" - 46"  |
|             | 3-stage locking tilt              | Grade 3 / Grade-in B                         | \$486.00 | Back 20" w x 21" h  |
|             | Free-float rocking tilt           | Grade 4 / Grade-in C                         | \$501.00 | Seat 20.5" w x 18-21.1" d   |
|             | <b>Synchronous seat/back tilt</b> | Grade 5 / Grade-in D                         | \$516.00 | Seat height 16.5" - 21.5"   |
|             | Sliding seat                      | Grade 6 / Grade-in E                         | \$531.00 | COM 1 yd.   |
|             | Tension knob                      | Evita leather<br>(Black/White/Stone/Vanilla) | \$656.00 | Carton weight 52 pounds<br>UPS weight 101 pounds<br>Arms Groups 1 & 4<br>Warranty 12 year limited |



| Model | Description               | Value Line | Textile Grade-In                             | List     | Specifications  |
|-------|---------------------------|------------|--|----------|---|
| PA57D | Pneumatic lift            |            | Grade 1 / C.O.M.                             | \$387.00 | Overall width 25"   |
|       | Tilting backrest          |            | Grade 2 / Grade-in A                         | \$402.00 | Overall height 37" - 45"  |
|       | EZ back height adjustment |            | Grade 3 / Grade-in B                         | \$417.00 | Back 19" w x 19" h  |
|       | Seat tilting              |            | Grade 4 / Grade-in C                         | \$432.00 | Seat 21" w x 18-21.1" d   |
|       | Seat depth adjustment     |            | Grade 5 / Grade-in D                         | \$447.00 | Seat height 17" - 22"   |
|       |                           |            | Grade 6 / Grade-in E                         | \$462.00 | COM 1 yd.   |
|       |                           |            | Evita leather<br>(Black/White/Stone/Vanilla) | \$587.00 | Carton weight 56 pounds<br>UPS weight 101 pounds<br>Arms Groups 1 & 4<br>Warranty 12 year limited |



| Model [NEW] | Description                       | Value Line | Textile Grade-In                             | List     | Specifications  |
|-------------|-----------------------------------|------------|--|----------|---|
| PA67        | Pneumatic lift                    |            | Grade 1 / C.O.M.                             | \$437.00 | Overall width 27"   |
|             | EZ back height adjustment         |            | Grade 2 / Grade-in A                         | \$452.00 | Overall height 37" - 45"  |
|             | 3-stage locking tilt              |            | Grade 3 / Grade-in B                         | \$467.00 | Back 19" w x 19" h  |
|             | Free-float rocking tilt           |            | Grade 4 / Grade-in C                         | \$482.00 | Seat 21" w x 18-21.1" d   |
|             | <b>Synchronous seat/back tilt</b> |            | Grade 5 / Grade-in D                         | \$497.00 | Seat height 17" - 22"   |
|             | Sliding seat                      |            | Grade 6 / Grade-in E                         | \$512.00 | COM 1 yd.   |
|             | Tension knob                      |            | Evita leather<br>(Black/White/Stone/Vanilla) | \$637.00 | Carton weight 56 pounds<br>UPS weight 101 pounds<br>Arms Groups 1 & 4<br>Warranty 12 year limited |



# patriot series (PA)

value line | general office

Please see pages 79, 138 -149 for arm kits, casters, and other options.

average / medium

## Model

PA58



## Description

Value Line

|                           |
|---------------------------|
| Pneumatic lift            |
| Tilting backrest          |
| EZ back height adjustment |
| Seat tilting              |
| Seat depth adjustment     |
| <b>Fabric panel back</b>  |

## Textile Grade-In

|  |          |
|--|----------|
| Grade 1 / C.O.M.                             | \$406.00 |
| Grade 2 / Grade-in A                         | \$421.00 |
| Grade 3 / Grade-in B                         | \$436.00 |
| Grade 4 / Grade-in C                         | \$451.00 |
| Grade 5 / Grade-in D                         | \$466.00 |
| Grade 6 / Grade-in E                         | \$481.00 |
| Evita leather<br>(Black/White/Stone/Vanilla) | \$606.00 |

## List

## Specifications

|                |                    |
|----------------|--------------------|
| Overall width  | 25"                |
| Overall height | 37" - 45"          |
| Back           | 19" w x 19" h      |
| Seat           | 21" w x 18-21.1" d |
| Seat height    | 17" - 22"          |
| COM            | 1.5 yds.           |
| Carton weight  | 56 pounds          |
| UPS weight     | 101 pounds         |
| Arms           | Groups 1 & 4       |
| Warranty       | 12 year limited    |

## Model [NEW]

PA68



## Description

Value Line

|                            |
|----------------------------|
| Pneumatic lift             |
| EZ back height adjustment  |
| 3-stage locking tilt       |
| Free-float rocking tilt    |
| Synchronous seat/back tilt |
| Sliding seat               |
| Tension knob               |
| <b>Fabric panel back</b>   |

## Textile Grade-In

|  |          |
|--|----------|
| Grade 1 / C.O.M.                             | \$456.00 |
| Grade 2 / Grade-in A                         | \$471.00 |
| Grade 3 / Grade-in B                         | \$486.00 |
| Grade 4 / Grade-in C                         | \$501.00 |
| Grade 5 / Grade-in D                         | \$516.00 |
| Grade 6 / Grade-in E                         | \$531.00 |
| Evita leather<br>(Black/White/Stone/Vanilla) | \$656.00 |

## List

## Specifications

|                |                    |
|----------------|--------------------|
| Overall width  | 27"                |
| Overall height | 37" - 45"          |
| Back           | 19" w x 19" h      |
| Seat           | 21" w x 18-21.1" d |
| Seat height    | 17" - 22"          |
| COM            | 1.5 yds.           |
| Carton weight  | 56 pounds          |
| UPS weight     | 101 pounds         |
| Arms           | Groups 1 & 4       |
| Warranty       | 12 year limited    |

Please see pages 138 - 149 for arm kits, casters, and other options.

large / xtra tall

| Model | Description               | Value Line | Textile Grade-In            | List                     | Specifications             |
|-------|---------------------------|------------|-----------------------------|--------------------------|----------------------------|
| PA59  | Pneumatic lift            |            | Grade 1 / C.O.M.            | \$430.00                 | Overall width 27"          |
|       | Tilting backrest          |            | Grade 2 / Grade-in A        | \$445.00                 | Overall height 42.5" - 50" |
|       | EZ back height adjustment |            | Grade 3 / Grade-in B        | \$460.00                 | Back 20.5" w x 25" h       |
|       | Seat tilting              |            | Grade 4 / Grade-in C        | \$475.00                 | Seat 21" w x 18-21.1" d    |
|       | Seat depth adjustment     |            | Grade 5 / Grade-in D        | \$490.00                 | Seat height 17" - 22"      |
|       |                           |            | Grade 6 / Grade-in E        | \$505.00                 | COM 1.5 yds.               |
|       |                           |            | Evita leather               |                          | Carton weight 59 pounds    |
|       |                           |            | (Black/White/Stone/Vanilla) | \$680.00                 | UPS weight 101 pounds      |
|       |                           |            |                             | Arms Groups 1 & 4        |                            |
|       |                           |            |                             | Warranty 12 year limited |                            |



| Model [NEW] | Description                | Textile Grade-In            | List              | Specifications             |
|-------------|----------------------------|-----------------------------|-------------------|----------------------------|
| PA69        | Pneumatic lift             | Grade 1 / C.O.M.            | \$480.00          | Overall width 27"          |
|             | EZ back height adjustment  | Grade 2 / Grade-in A        | \$495.00          | Overall height 42.5" - 50" |
|             | 3-stage locking tilt       | Grade 3 / Grade-in B        | \$510.00          | Back 20.5" w x 25" h       |
|             | Free-float rocking tilt    | Grade 4 / Grade-in C        | \$525.00          | Seat 21" w x 18-21.1" d    |
|             | Synchronous seat/back tilt | Grade 5 / Grade-in D        | \$540.00          | Seat height 17" - 22"      |
|             | Sliding seat               | Grade 6 / Grade-in E        | \$555.00          | COM 1.5 yds.               |
|             | Tension knob               | Evita leather               |                   | Carton weight 59 pounds    |
|             |                            | (Black/White/Stone/Vanilla) | \$730.00          | UPS weight 101 pounds      |
|             |                            |                             | Arms Groups 1 & 4 |                            |
|             |                            |                             |                   | Warranty 12 year limited   |



side chair

| Model | Description | Value Line                  | Textile Grade-In     | List                     | Specifications          |
|-------|-------------|-----------------------------|----------------------|--------------------------|-------------------------|
| PA61S | Sled base   |                             | Grade 1 / C.O.M.     | \$264.00                 | Overall width 22"       |
|       |             |                             | Grade 2 / Grade-in A | \$279.00                 | Overall height 38.5"    |
|       |             |                             | Grade 3 / Grade-in B | \$294.00                 | Back 20" w x 21" h      |
|       |             |                             | Grade 4 / Grade-in C | \$309.00                 | Seat 20.5" w x 19" d    |
|       |             |                             | Grade 5 / Grade-in D | \$324.00                 | Seat height 18"         |
|       |             |                             | Grade 6 / Grade-in E | \$339.00                 | COM 1 yd.               |
|       |             |                             | Evita leather        |                          | Carton weight 38 pounds |
|       |             | (Black/White/Stone/Vanilla) | \$464.00             | UPS weight 62 pounds     |                         |
|       |             |                             |                      | Arms Groups 1 & 4        |                         |
|       |             |                             |                      | Warranty 12 year limited |                         |



common options

### Suggested Options for Patriot PA Series

| Arms kits  |   |
|--|---|
| <p><b>KR-200</b> - list: 109.00<br/>Height and width adjustable and removable T-arms with natural grip control. Adjustable height range of 2.75". Adjustable width range of approximately 1.25" per side. 12 year limited warranty on arm frames &amp; 2 year limited warranty on arm pads*</p>                  | <p><b>KR-21</b> - list: 65.00<br/>Contoured height adjustable T arms<br/>Adjustable height range of 2.25"<br/>12 year limited warranty</p>  |
| <p><b>JR-39</b> - list: 122.00<br/>2-way adjustable width/height and removable Forward-slanting T-arms with soft arm pads and natural grip control. Black only. Adjustable height range of 4.25". Adjustable width range of 1.75" each side. 7 year limited warranty on arm frames &amp; 2 year on arm pads*</p> | <p><b>JR-49</b> - list: 186.00<br/>2-way adjustable (W/H) forward-slanting T-arms with RP45 arm pads. Black only. Adjustable height range of 4.25". Adjustable width range of 1.75". 7 year limited warranty on arm frames &amp; 2 year limited warranty on arm pads*</p> |

# patriot series (PC)

general office

Please see pages 81, 138 -149 for arm kits, casters, and other options.

small / petite

| Model | Description               | Value Line | Textile Grade-In            | List     | Specifications           |
|-------|---------------------------|------------|-----------------------------|----------|--------------------------|
| PC53  | Pneumatic lift            |            | Grade 1 / C.O.M.            | \$417.00 | Overall width 25"        |
|       | Tilting backrest          |            | Grade 2 / Grade-in A        | \$432.00 | Overall height 32" - 40" |
|       | EZ back height adjustment |            | Grade 3 / Grade-in B        | \$447.00 | Back 17.5" w x 16.5" h   |
|       | Seat tilting              |            | Grade 4 / Grade-in C        | \$462.00 | Seat 19" w x 17-20.1" d  |
|       | Seat depth adjustment     |            | Grade 5 / Grade-in D        | \$477.00 | Seat height 16" - 21"    |
|       | Rocking tilt              |            | Grade 6 / Grade-in E        | \$492.00 | COM 1 yd.                |
|       | Infinite forward tilting  |            | Evita leather               |          | Carton weight 54 pounds  |
|       | Tension knob              |            | (Black/White/Stone/Vanilla) | \$617.00 | UPS weight 101 pounds    |
|       |                           |            |                             |          | Arms Group 1 & 4         |
|       |                           |            |                             |          | Warranty 12 year limited |



300 POUNDS CAPACITY

average / medium

| Model | Description               | Value Line | Textile Grade-In            | List     | Specifications            |
|-------|---------------------------|------------|-----------------------------|----------|---------------------------|
| PC55  | Pneumatic lift            |            | Grade 1 / C.O.M.            | \$464.00 | Overall width 27"         |
|       | Tilting backrest          |            | Grade 2 / Grade-in A        | \$479.00 | Overall height 38" - 46"  |
|       | EZ back height adjustment |            | Grade 3 / Grade-in B        | \$494.00 | Back 20" w x 21" h        |
|       | Seat tilting              |            | Grade 4 / Grade-in C        | \$509.00 | Seat 20.5" w x 18-21.1" d |
|       | Seat depth adjustment     |            | Grade 5 / Grade-in D        | \$524.00 | Seat height 16.5" - 21.5" |
|       | Rocking tilt              |            | Grade 6 / Grade-in E        | \$539.00 | COM 1 yd.                 |
|       | Infinite forward tilting  |            | Evita leather               |          | Carton weight 52 pounds   |
|       | Tension knob              |            | (Black/White/Stone/Vanilla) | \$664.00 | UPS weight 101 pounds     |
|       |                           |            |                             |          | Arms Group 1 & 4          |
|       |                           |            |                             |          | Warranty 12 year limited  |



300 POUNDS CAPACITY

| Model | Description               | Value Line | Textile Grade-In            | List     | Specifications            |
|-------|---------------------------|------------|-----------------------------|----------|---------------------------|
| PC57D | Pneumatic lift            |            | Grade 1 / C.O.M.            | \$445.00 | Overall width 27"         |
|       | Tilting backrest          |            | Grade 2 / Grade-in A        | \$460.00 | Overall height 37" - 45"  |
|       | EZ back height adjustment |            | Grade 3 / Grade-in B        | \$475.00 | Back 19" w x 19" h        |
|       | Seat tilting              |            | Grade 4 / Grade-in C        | \$490.00 | Seat 21" w x 17.5-20.6" d |
|       | Seat depth adjustment     |            | Grade 5 / Grade-in D        | \$505.00 | Seat height 17" - 22"     |
|       | Rocking tilt              |            | Grade 6 / Grade-in E        | \$520.00 | COM 1 yd.                 |
|       | Infinite forward tilting  |            | Evita leather               |          | Carton weight 56 pounds   |
|       | Tension knob              |            | (Black/White/Stone/Vanilla) | \$645.00 | UPS weight 101 pounds     |
|       |                           |            |                             |          | Arms Group 1 & 4          |
|       |                           |            |                             |          | Warranty 12 year limited  |



300 POUNDS CAPACITY

| Model | Description               | Value Line | Textile Grade-In            | List     | Specifications           |
|-------|---------------------------|------------|-----------------------------|----------|--------------------------|
| PC58  | Pneumatic lift            |            | Grade 1 / C.O.M.            | \$464.00 | Overall width 27"        |
|       | Tilting backrest          |            | Grade 2 / Grade-in A        | \$479.00 | Overall height 37" - 45" |
|       | EZ back height adjustment |            | Grade 3 / Grade-in B        | \$494.00 | Back 19" w x 19" h       |
|       | Seat tilting              |            | Grade 4 / Grade-in C        | \$509.00 | Seat 21" w x 18-21.1" d  |
|       | Seat depth adjustment     |            | Grade 5 / Grade-in D        | \$524.00 | Seat height 17" - 22"    |
|       | Rocking tilt              |            | Grade 6 / Grade-in E        | \$539.00 | COM 1.5 yds.             |
|       | Infinite forward tilting  |            | Evita leather               |          | Carton weight 56 pounds  |
|       | Tension knob              |            | (Black/White/Stone/Vanilla) | \$664.00 | UPS weight 101 pounds    |
|       | Fabric panel back         |            |                             |          | Arms Group 1 & 4         |
|       |                           |            |                             |          | Warranty 12 year limited |



300 POUNDS CAPACITY

omsmartsitting.com





Please see pages 138 - 149 for arm kits, casters, and other options.

large / xtra tall

**Model**

PC59



300 POUNDS CAPACITY

**Description**

|                           |
|---------------------------|
| Pneumatic lift            |
| Tilting backrest          |
| EZ back height adjustment |
| Seat tilting              |
| Seat depth adjustment     |
| Rocking tilt              |
| Infinite forward tilting  |
| Tension knob              |

**Value Line**

**Textile Grade-In**

|  |          |
|--|----------|
| Grade 1 / C.O.M.                             | \$488.00 |
| Grade 2 / Grade-in A                         | \$503.00 |
| Grade 3 / Grade-in B                         | \$518.00 |
| Grade 4 / Grade-in C                         | \$533.00 |
| Grade 5 / Grade-in D                         | \$548.00 |
| Grade 6 / Grade-in E                         | \$563.00 |
| Evita leather<br>(Black/White/Stone/Vanilla) | \$738.00 |

**List**

**Specifications**

|                |                    |
|----------------|--------------------|
| Overall width  | 27"                |
| Overall height | 42.5" - 50"        |
| Back           | 20.5" w x 25" h    |
| Seat           | 21" w x 18-21.1" d |
| Seat height    | 17" - 22"          |
| COM            | 1.5 yds.           |
| Carton weight  | 59 pounds          |
| UPS weight     | 101 pounds         |
| Arms           | Groups 1 & 4       |
| Warranty       | 12 year limited    |

common options

**Suggested Options for PC Series**

**Arms kits**



**KR-240M** - list: 134.00

Lowest height and width adjustable and removable T-arms with natural grip control with Memosoft Pad. Adjustable height range of 2.75". Adjustable width range of approximately 1.25" per side. 12 year limited warranty on arm frames & 2 year limited warrant on arm pads\*

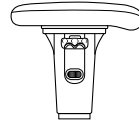

**KR-540** - list: 219.00

Lower starting-height version of KR-500 (based on KR-240 arm frame). 12 year limited warranty on arm frames & 2 year limited warranty on arm pads\*



**KR-445** - list: 175.00

Height and width adjustable T-arms with smooth fore-aft, side-to-side, and pivoting motion arm caps. Adjustable width range of approximately 1.25" per side. 12 year limited warranty on arm frames & 2 year limited warranty on arm pads\*



**JR-39** - list: 122.00

2-way adjustable width/height and removable. Forward-slanting T-arms with soft arm pads and natural grip control. Black only. Adjustable height range of 4.25". Adjustable width range of 1.75" each side. 7 year limited warranty on arm frames & 2 year on arm pads\*



## features:

Begins @ \$439 armless / \$548 with KR-200 arms (YS72)

Mesh-backed chairs with upholstered seats for a wide range of work environments

Sigh-producing soft cushions with a comfortable, mild saddle contour

A full suite of available mechanisms to achieve any level of adjustability desired

Timeless traditional mesh aesthetic in one of our most proven choices!



**YS70N**

Pictured here with arms (standard)  
and Grade 5 Comfort Knit  
Solids Xanadu upholstery  
\$361.00 List (as shown)



**YS88**

Pictured here with Grade 5 Comfort Knit  
Solids Xanadu upholstery  
\$554.00 List (as shown)



**YS78**

Pictured here with optional arms  
and Grade 5 Comfort Knit  
Solids Xanadu upholstery

→  
Use our  
handy  
stickers to  
mark this  
section.  
yes series  
(YS)

# yes series (YS)

conference | boardroom | executive

Please see pages 86, 138 -149 for arm kits, casters, and other options.

average / medium back

## Model

### YS72



## Description

Pneumatic lift  
EZ back height adjustment  
Infinitely locking seat tilt  
Infinitely locking back tilt  
Mesh back (mid)  
Seat depth adjustment

## Textile Grade-In

Grade 1 / C.O.M. \$439.00  
Grade 2 / Grade-in A \$449.00  
Grade 3 / Grade-in B \$459.00  
Grade 4 / Grade-in C \$469.00  
Grade 5 / Grade-in D \$479.00  
Grade 6 / Grade-in E \$489.00  
Evita leather  
(Black/White/Stone/Vanilla) \$564.00

## List

## Specifications

Overall width 27"  
Overall height 33" - 41"  
Back 19" w x 20" h  
Seat 20.5" w x 18-21.1" d  
Seat height 17" - 22"  
COM 1 yd.  
Carton weight 52 pounds  
UPS weight 101 pounds  
Arms Group 1 & 4  
Warranty 12 year limited

## Model

### YS74



## Description

Pneumatic lift  
EZ back height adjustment  
3-stage locking tilt  
Synchronous seat/back tilt  
Mesh back (mid)  
Seat depth adjustment  
Free-float rocking tilt  
Tension knob

## Textile Grade-In

Grade 1 / C.O.M. \$450.00  
Grade 2 / Grade-in A \$460.00  
Grade 3 / Grade-in B \$470.00  
Grade 4 / Grade-in C \$480.00  
Grade 5 / Grade-in D \$490.00  
Grade 6 / Grade-in E \$500.00  
Evita leather  
(Black/White/Stone/Vanilla) \$575.00

## List

## Specifications

Overall width 27"  
Overall height 35.5" - 43.5"  
Back 19" w x 20" h  
Seat 20.5" w x 18-21.1" d  
Seat height 17.5" - 22.5"  
COM 1 yd.  
Carton weight 52 pounds  
UPS weight 101 pounds  
Arms Group 1 & 4  
Warranty 12 year limited

## Model

### YS84



300  
POUNDS  
CAPACITY

## Description

Pneumatic lift  
EZ back height adjustment  
Tilting backrest  
Rocking tilt  
Forward tilting  
Tension knob  
Mesh back (mid)  
Seat depth adjustment  
Infinite forward tilting

## Textile Grade-In

Grade 1 / C.O.M. \$480.00  
Grade 2 / Grade-in A \$490.00  
Grade 3 / Grade-in B \$500.00  
Grade 4 / Grade-in C \$510.00  
Grade 5 / Grade-in D \$520.00  
Grade 6 / Grade-in E \$530.00  
Evita leather  
(Black/White/Stone/Vanilla) \$605.00

## List

## Specifications

Overall width 27"  
Overall height 36" - 44"  
Back 19" w x 20" h  
Seat 21" w x 18-21.1" d  
Seat height 17" - 22"  
COM 1 yd.  
Carton weight 54 pounds  
UPS weight 101 pounds  
Arms Group 1 & 4  
Warranty 12 year limited

Please see pages 86, 138 - 149 for arm kits, casters, and other options.

high back / high back with headrest

| Model   | Description                      | Textile Grade-In            | List     | Specifications               |
|---|----------------------------------|-----------------------------|----------|------------------------------|
| <br>YS78 | Pneumatic lift                   | Grade 1 / C.O.M.            | \$483.00 | Overall width 27"            |
|   | 3-stage locking tilt             | Grade 2 / Grade-in A        | \$493.00 | Overall height 41.5" - 49.5" |
|   | Free-float rocking tilt          | Grade 3 / Grade-in B        | \$503.00 | Back 20" w x 24" h           |
|   | Titanium colored metal base      | Grade 4 / Grade-in C        | \$513.00 | Seat 20.5" w x 18-20" d      |
|   | Synchronous seat/back tilt       | Grade 5 / Grade-in D        | \$523.00 | Seat height 17.5" - 22.5"    |
|   | Mesh back (high)                 | Grade 6 / Grade-in E        | \$533.00 | COM 1 yd.                    |
|   | Seat depth adjustment            | Evita leather               |          | Carton weight 53 pounds      |
|   | Dual-tone oversized soft casters | (Black/White/Stone/Vanilla) | \$608.00 | UPS weight 101 pounds        |
|   | Tension knob                     |                             |          | Arms Group 1 & 4             |
|   |                                  |                             |          | Warranty 12 year limited     |

| Model  | Description                      | Textile Grade-In            | List     | Specifications            |
|--|----------------------------------|-----------------------------|----------|---------------------------|
| <br>YS79 | Pneumatic lift                   | Grade 1 / C.O.M.            | \$586.00 | Overall width 27"         |
|  | 3-stage locking tilt             | Grade 2 / Grade-in A        | \$596.00 | Overall height 46" - 55"  |
|  | Free-float rocking tilt          | Grade 3 / Grade-in B        | \$606.00 | Back 20" w x 24" h        |
|  | Titanium colored metal base      | Grade 4 / Grade-in C        | \$616.00 | Seat 20.5" w x 18-20" d   |
|  | Synchronous seat/back tilt       | Grade 5 / Grade-in D        | \$626.00 | Seat height 17.5" - 22.5" |
|  | Mesh back (high)                 | Grade 6 / Grade-in E        | \$636.00 | COM 1 yd.                 |
|  | Seat depth adjustment            | Evita leather               |          | Carton weight 63 pounds   |
|  | Dual-tone oversized soft casters | (Black/White/Stone/Vanilla) | \$711.00 | UPS weight 101 pounds     |
|  | Tension knob                     |                             |          | Arms Group 1 & 4          |
|  | Adjustable headrest*             |                             |          | Warranty 12 year limited  |

| Model   | Description               | Textile Grade-In            | List     | Specifications           |
|---|---------------------------|-----------------------------|----------|--------------------------|
| <br>YS88 | Pneumatic lift            | Grade 1 / C.O.M.            | \$514.00 | Overall width 27"        |
|   | EZ back height adjustment | Grade 2 / Grade-in A        | \$524.00 | Overall height 40" - 48" |
|   | Tilting backrest          | Grade 3 / Grade-in B        | \$534.00 | Back 19" w x 24" h       |
|   | Rocking tilt              | Grade 4 / Grade-in C        | \$544.00 | Seat 21" w x 18-21.1" d  |
|   | Forward tilting           | Grade 5 / Grade-in D        | \$554.00 | Seat height 17 - 22"     |
|   | Tension knob              | Grade 6 / Grade-in E        | \$564.00 | COM 1 yd.                |
|   | Mesh back (high)          | Evita leather               |          | Carton weight 55 pounds  |
|   | Seat depth adjustment     | (Black/White/Stone/Vanilla) | \$639.00 | UPS weight 101 pounds    |
|   | Infinite forward tilting  |                             |          | Arms Groups 1 & 4        |
|   |                           |                             |          | Warranty 12 year limited |

| Model   | Description               | Textile Grade-In               | List     | Specifications             |
|---|---------------------------|--------------------------------|----------|----------------------------|
| <br>YS89 | Pneumatic lift            | Grade 1 / C.O.M.               | \$620.00 | Overall width 27"          |
|   | EZ back height adjustment | Grade 2 / Grade-in A           | \$630.00 | Overall height 44.5" - 54" |
|   | Tilting backrest          | Grade 3 / Grade-in B           | \$640.00 | Back 19" w x 24" h         |
|   | Rocking tilt              | Grade 4 / Grade-in C           | \$650.00 | Seat 21" w x 18-21.1" d    |
|   | Forward tilting           | Grade 5 / Grade-in D           | \$660.00 | Seat height 17" - 22"      |
|   | Tension knob              | Grade 6 / Grade-in E           | \$670.00 | COM 1 yd.                  |
|   | Mesh back (high)          | Evita leather                  |          | Carton weight 58 pounds    |
|   | Seat depth adjustment     | (Black, Stone, Vanilla, White) | \$745.00 | UPS weight 101 pounds      |
|   | Adjustable headrest*      |                                |          | Arms Groups 1 & 4          |
|   | Infinite forward tilting  |                                |          | Warranty 12 year limited   |

\*Optional mesh (unupholstered) headrest option HR-YSM - Subtract \$28 from list.

# yes series (YS)

conference | boardroom | executive

Please see pages 138 -149 for arm kits, casters, and other options.

stools

| Model   | Description                      | Textile Grade-In            | List     | Specifications            |
|---|----------------------------------|-----------------------------|----------|---------------------------|
| <br>YS73 | Pneumatic lift                   | Grade 1 / C.O.M.            | \$480.00 | Overall width 27"         |
|   | Infinitely locking back tilt     | Grade 2 / Grade-in A        | \$490.00 | Overall height 46" - 57"  |
|   | EZ back height adjustment        | Grade 3 / Grade-in B        | \$500.00 | Back 19" w x 20" h        |
|   | Mesh back                        | Grade 4 / Grade-in C        | \$510.00 | Seat 20.5" w x 18-21.1" d |
|   | Seat depth adjustment            | Grade 5 / Grade-in D        | \$520.00 | Seat height 25" - 33"     |
|   | HD Spider base                   | Grade 6 / Grade-in E        | \$530.00 | COM 1 yd.                 |
|   | Bright chrome finish             | Evita leather               |          | Carton weight 56 pounds   |
|   | Dual-tone oversized soft casters | (Black/White/Stone/Vanilla) | \$605.00 | UPS weight 101 pounds     |
|   |                                  |                             |          | Arms Group 1 & 4          |
|   |                                  |                             |          | Warranty 12 year limited  |



| Model   | Description                      | Textile Grade-In            | List     | Specifications            |
|---|----------------------------------|-----------------------------|----------|---------------------------|
| <br>YS75 | Pneumatic lift                   | Grade 1 / C.O.M.            | \$566.00 | Overall width 27"         |
|   | EZ back height adjustment        | Grade 2 / Grade-in A        | \$576.00 | Overall height 43" - 57"  |
|   | Infinitely locking back tilt     | Grade 3 / Grade-in B        | \$586.00 | Back 19" w x 20" h        |
|   | Titanium colored metal base      | Grade 4 / Grade-in C        | \$596.00 | Seat 20.5" w x 18-21.1" d |
|   | Mesh back                        | Grade 5 / Grade-in D        | \$606.00 | Seat height 23" - 33"     |
|   | Seat depth adjustment            | Grade 6 / Grade-in E        | \$616.00 | COM 1 yd.                 |
|   | 20" chrome footring              | Evita leather               |          | Carton weight 58 pounds   |
|   | Bright chrome finish             | (Black/White/Stone/Vanilla) | \$691.00 | UPS weight 101 pounds     |
|   | Knobless, turn-lock footring     |                             |          | Arms Group 1 & 4          |
|   | Dual-tone oversized soft casters |                             |          | Warranty 12 year limited  |

large / xtra tall

| Model   | Description               | Textile Grade-In            | List       | Specifications              |
|---|---------------------------|-----------------------------|------------|-----------------------------|
| <br>YSYM | Pneumatic lift            | Grade 1 / C.O.M.            | \$882.00   | Overall width 28"           |
|   | EZ back height adjustment | Grade 2 / Grade-in A        | \$892.00   | Overall height 42" - 52"    |
|   | Tilting backrest          | Grade 3 / Grade-in B        | \$902.00   | Back 19" w x 24" h          |
|   | Rocking tilt              | Grade 4 / Grade-in C        | \$912.00   | Seat 23.5" w x 21.5-24.6" d |
|   | Forward tilting           | Grade 5 / Grade-in D        | \$922.00   | Seat height 19" - 25"       |
|   | Tension knob              | Grade 6 / Grade-in E        | \$932.00   | COM 1 yd.                   |
|   | Mesh back                 | Evita leather               |            | Carton weight 55 pounds     |
|   | Seat depth adjustment     | (Black/White/Stone/Vanilla) | \$1,007.00 | UPS weight 101 pounds       |
|   | Infinite forward tilting  |                             |            | Arms Group 1 & 4            |
|   |                           |                             |            | Warranty 12 year limited    |

common options

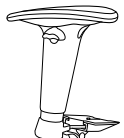
### Suggested Options for Yes Series

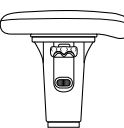
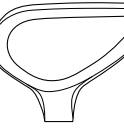
|  |   |
|--|---|
|  <p><b>Arms kits</b></p> <p><b>JR-39</b> - list: 122.00<br/>2-way adjustable width/height and removable Forward-slanting T-arms with soft arm pads and natural grip control. Black only. Adjustable height range of 4.25". Adjustable width range of 1.75" each side. 7 year limited warranty on arm frames &amp; 2 year on arm pads*</p> |  <p><b>JR-49</b> - list: 186.00<br/>2-way adjustable (W/H) forward-slanting T-arms with RP45 arm pads. Black only. Adjustable height range of 4.25". Adjustable width range of 1.75". 7 year limited warranty on arm frames &amp; 2 year limited warranty on arm pads*</p> |
|  <p><b>KR-540</b> - list: 219.00<br/>Lower starting-height version of KR-500 (based on KR-240 arm frame)<br/>12 year limited warranty on arm frames &amp; 2 year limited warranty on arm pads*</p>  |  <p><b>KR-48</b> - list: 99.00<br/>Fixed loop arms<br/>7 year limited warranty*</p>  |

omsmartseating.com

SMART SEATING



Please see page 149 for some relevant options.

side and nesting chairs

**Model**

YS70N



**Description**

Convenient nesting chair design  
Mesh back  
Fixed arms standard

**Textile Grade-In**

Grade 1 / C.O.M. \$321.00  
Grade 2 / Grade-in A \$331.00  
Grade 3 / Grade-in B \$341.00  
Grade 4 / Grade-in C \$351.00  
Grade 5 / Grade-in D \$361.00  
Grade 6 / Grade-in E \$371.00  
Evita leather  
(Black/White/Stone/Vanilla) \$446.00

**List**

**Specifications**

Overall width 24.5"  
Overall height 37"  
Back 20" w x 20" h  
Seat 19" w x 19" d  
Seat height 18"  
COM 1 yd.  
Carton weight 38 pounds  
UPS weight 85 pounds  
Arms Included  
Warranty 12 year limited

**Model**

YS71N



**Description**

Convenient nesting chair design  
Mesh back  
Armless

**Textile Grade-In**

Grade 1 / C.O.M. \$319.00  
Grade 2 / Grade-in A \$329.00  
Grade 3 / Grade-in B \$339.00  
Grade 4 / Grade-in C \$349.00  
Grade 5 / Grade-in D \$359.00  
Grade 6 / Grade-in E \$369.00  
Evita leather  
(Black/White/Stone/Vanilla) \$444.00

**List**

**Specifications**

Overall width 24.5"  
Overall height 37"  
Back 20" w x 20" h  
Seat 19" w x 19" d  
Seat height 18"  
COM 1 yd.  
Carton weight 37 pounds  
UPS weight 85 pounds  
Arms N/A  
Warranty 12 year limited

**Model**

YS71S



**Description**

Mesh back (mid)  
Cantilever sled base  
Optional arms available

**Textile Grade-In**

Grade 1 / C.O.M. \$273.00  
Grade 2 / Grade-in A \$283.00  
Grade 3 / Grade-in B \$293.00  
Grade 4 / Grade-in C \$303.00  
Grade 5 / Grade-in D \$313.00  
Grade 6 / Grade-in E \$323.00  
Evita leather  
(Black/White/Stone/Vanilla) \$398.00

**List**

**Specifications**

Overall width 21"  
Overall height 39.5"  
Back 19" w x 20" h  
Seat 20.5" w x 18" d  
Seat height 19"  
COM 1 yd.  
Carton weight 41 pounds  
UPS weight 62 pounds  
Arms Group 1 & 4  
Warranty 12 year limited

**Model**

YS76S



**Description**

Mesh back (high)  
Cantilever sled base  
Optional arms available

**Textile Grade-In**

Grade 1 / C.O.M. \$313.00  
Grade 2 / Grade-in A \$323.00  
Grade 3 / Grade-in B \$333.00  
Grade 4 / Grade-in C \$343.00  
Grade 5 / Grade-in D \$353.00  
Grade 6 / Grade-in E \$363.00  
Evita leather  
(Black/White/Stone/Vanilla) \$438.00

**List**

**Specifications**

Overall width 21"  
Overall height 41.5"  
Back 20" w x 24" h  
Seat 20.5" w x 18" d  
Seat height 18.5"  
COM 1 yd.  
Carton weight 41 pounds  
UPS weight 100 pounds  
Arms Group 1 & 4  
Warranty 12 year limited







## features:

Begins @ \$405 armless / \$514 with KR-200 arms (ZA62)

ZA6x – Elegant, tuxedo back chair that was simplified for conference rooms

ZA9x – Ergonomic adjustments and a backrest that was contoured for executives

Fully adjustable articulating headrest option and sharp-looking polished aluminum base



### **ZA62**

Pictured here with  
Grade 1 Elements Carbon upholstery  
\$405.00 List



### **ZA98**

Pictured here armless with  
Grade 5 Comfort Knit Solids upholstery  
\$766.00 List

→  
Use our  
handy  
stickers to  
mark this  
section.  
zesta series  
(ZA)

# zesta series (ZA)

general office

Please see pages 91, 138 -149 for arm kits, casters, and other options.

synchronized

| Model   | Description                      | Textile Grade-In            | List             | Specifications               |                   |
|---|----------------------------------|-----------------------------|------------------|------------------------------|-------------------|
|  | ZA62                             | Pneumatic lift              | Grade 1 / C.O.M. | \$405.00                     | Overall width 27" |
|   | 3-stage locking tilt             | Grade 2 / Grade-in A        | \$425.00         | Overall height 39.5" - 48.5" |                   |
|   | Synchronous back/seat tilt       | Grade 3 / Grade-in B        | \$445.00         | Back 20" w x 26" h           |                   |
|   | Tension knob                     | Grade 4 / Grade-in C        | \$465.00         | Seat 20.5" w x 19" d         |                   |
|   | Positive back release            | Grade 5 / Grade-in D        | \$485.00         | Seat height 17.5" - 22.5"    |                   |
|   | Dual-tone oversized soft casters | Grade 6 / Grade-in E        | \$505.00         | COM 2 yds.                   |                   |
|   | Polished aluminum base           | Evita leather               |                  | Carton weight 53 pounds      |                   |
|   |                                  | (Black/White/Stone/Vanilla) | \$655.00         | UPS weight 101 pounds        |                   |
|   |                                  |                             |                  | Arms Groups 1 & 4            |                   |
|   |                                  |                             |                  | Warranty 12 year limited     |                   |

| Model  | Description                      | Textile Grade-In            | List             | Specifications               |                   |
|--|----------------------------------|-----------------------------|------------------|------------------------------|-------------------|
|  | ZA66                             | Pneumatic lift              | Grade 1 / C.O.M. | \$463.00                     | Overall width 27" |
|  | 3-stage locking tilt             | Grade 2 / Grade-in A        | \$483.00         | Overall height 39.5" - 56.5" |                   |
|  | Synchronous back/seat tilt       | Grade 3 / Grade-in B        | \$503.00         | Back 20" w x 26" h           |                   |
|  | Tension knob                     | Grade 4 / Grade-in C        | \$523.00         | Seat 20.5" w x 19" d         |                   |
|  | Positive back release            | Grade 5 / Grade-in D        | \$543.00         | Seat height 17.5" - 22.5"    |                   |
|  | 3-way adjustable headrest        | Grade 6 / Grade-in E        | \$563.00         | COM 2 yds.                   |                   |
|  | Dual-tone oversized soft casters | Evita leather               |                  | Carton weight 54 pounds      |                   |
|  | Polished aluminum base           | (Black/White/Stone/Vanilla) | \$713.00         | UPS weight 101 pounds        |                   |
|  |                                  |                             |                  | Arms Groups 1 & 4            |                   |
|  |                                  |                             |                  | Warranty 12 year limited     |                   |

Please see pages 138 - 149 for arm kits, casters, and other options.

multi-function

**Model**

ZA94



**Description**

- Pneumatic lift
- EZ back height adjustment
- Seat depth adjustment
- Rocking tilt
- Tilting backrest
- Fabric panel back
- Forward tilting
- Tilting seat
- Tension knob
- Dual-tone oversized soft casters
- Polished aluminum base

**Textile Grade-In**

- Grade 1 / C.O.M. \$629.00
- Grade 2 / Grade-in A \$649.00
- Grade 3 / Grade-in B \$669.00
- Grade 4 / Grade-in C \$689.00
- Grade 5 / Grade-in D \$709.00
- Grade 6 / Grade-in E \$729.00
- Evita leather (Black/White/Stone/Vanilla) \$879.00

**List**

**Specifications**

- Overall width 27"
- Overall height 39.5" - 48.5"
- Back 20" w x 26" h
- Seat 20.5" w x 18-20" d
- Seat height 17.5" - 22.5"
- COM 2 yds.
- Carton weight 61 pounds
- UPS weight 101 pounds
- Arms Groups 1 & 4
- Warranty 12 year limited

**Model**

ZA98



**Description**

- Pneumatic lift
- EZ back height adjustment
- Seat depth adjustment
- Rocking tilt
- Tilting backrest
- Fabric panel back
- Forward tilting
- Tilting seat
- Tension knob
- 3-way adjustable headrest
- Dual-tone oversized soft casters
- Polished aluminum base

**Textile Grade-In**

- Grade 1 / C.O.M. \$686.00
- Grade 2 / Grade-in A \$706.00
- Grade 3 / Grade-in B \$726.00
- Grade 4 / Grade-in C \$746.00
- Grade 5 / Grade-in D \$766.00
- Grade 6 / Grade-in E \$786.00
- Evita leather (Black/White/Stone/Vanilla) \$936.00

**List**

**Specifications**

- Overall width 27"
- Overall height 39.5" - 56.5"
- Back 20" w x 26" h
- Seat 20.5" w x 18-20" d
- Seat height 17.5" - 22.5"
- COM 2 yds.
- Carton weight 66 pounds
- UPS weight 101 pounds
- Arms Groups 1 & 4
- Warranty 12 year limited

common options

**Suggested Options for Yes Series**

**Arms kits**

**KR-48** - list: 99.00  
Fixed loop arms  
7 year limited warranty\*

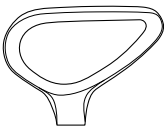

**ETR-1** - list: 40.00  
Fixed loop arms  
7 year limited warranty\*



**JR-39** - list: 122.00  
2-way adjustable width/height and removable  
Forward-slanting T-arms with soft arm pads and  
natural grip control. Black only. Adjustable height  
range of 4.25". Adjustable width range of 1.75"  
each side. 7 year limited warranty on arm frames &  
2 year on arm pads\*

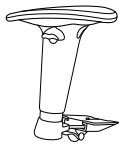

**KR-32** - list: 87.00  
Height adjustable open loop arms  
Adjustable height range of 2.25"  
12 year limited warranty on arm frames &  
2 year limited warranty on arm pads\*

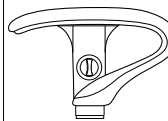

Above weights do not include optional arm kits. ; UPS weight is calculated using UPS dimensional standards to determine billable weight. ; Pricing and specifications subject to change without notification.



# guest stackable & specialty seating

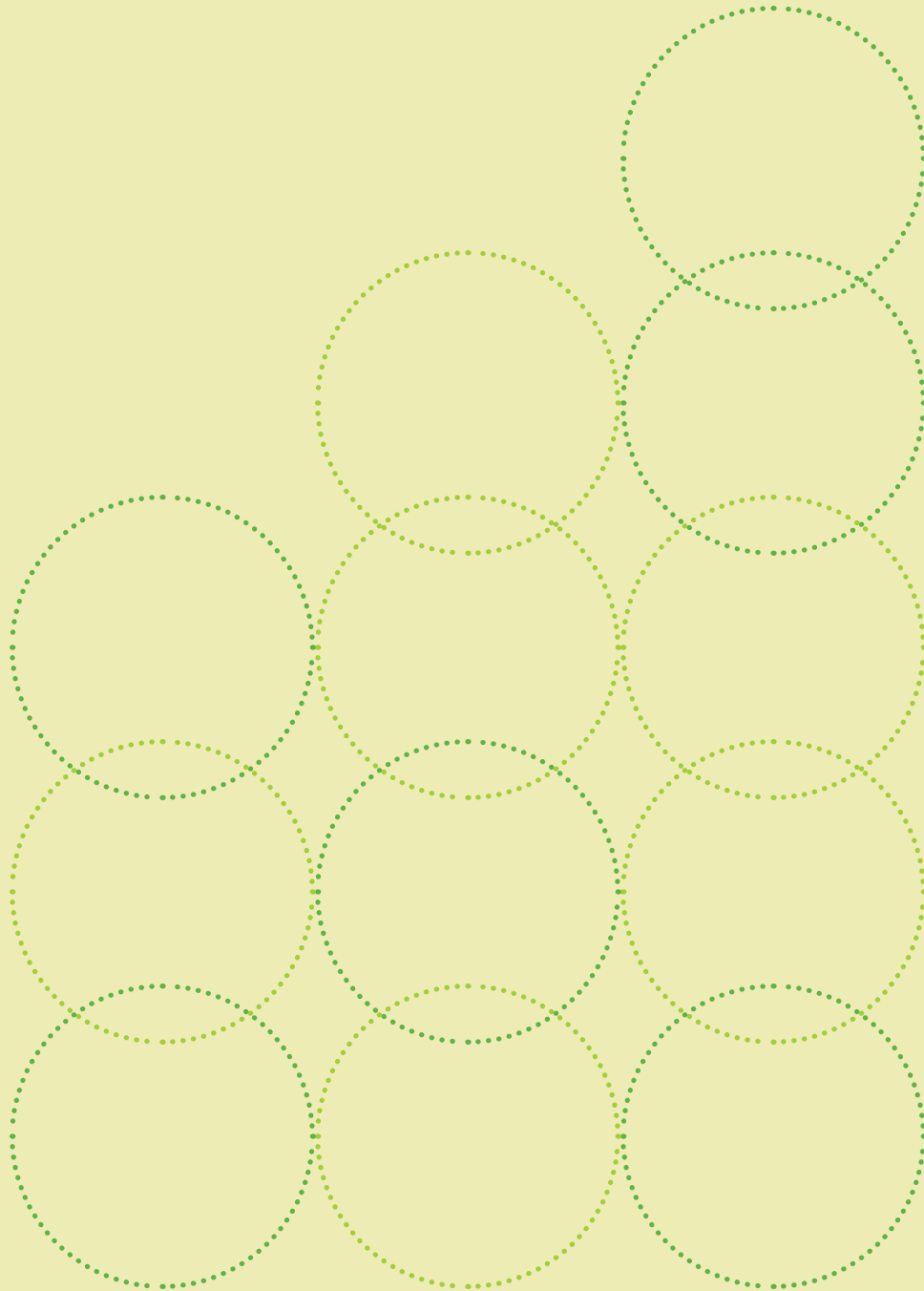

→  
Use our  
handy  
stickers to  
mark this  
section.

guest, stackable  
& specialty  
seating



## features:

Begins @ \$238 armless / \$276 with OM5 cantilever arms

OM5-AS – Sled-base mid-density stacking chair for any occasional use environment

OM5-AG – 4-Leg stackable guest chair with options for casters or glides.

OM5-AT – 5-Star base “tasker” for training rooms, computer labs, or simple task environments

OM5-AC – Sled-base, stackable café stools with both bar and counter height seat options  
(30” & 24” seat heights, respectively)



**OM5 Active Stack (AS)**  
\$238.00 List (as shown)



**OM5 Active Guest (AG)**  
\$311.00 List (as shown)



**OM5 Active Tasker (AT)**  
\$336.00 List (as shown)



**OM5 Active Café Stool (AC)**  
\$436.00 List (as shown)

→  
Use our  
handy  
stickers to  
mark this  
section.

# OM5 active tasker

stackable, guest & specialty seating



**OM5-AT Active Tasker**  
example: OM5-AT-A-PS-PF-PF-OB5-B25-TC

## OM5 Active Tasker (AT)

### DESCRIPTION

- One-piece, articulating plastic shell
- OM5 series® Body-Activated motion
- CA TB133-certified (no upcharge)
- Various aesthetic options (i.e., shell color, back/seat upholstery, etc.)
- Pneumatic lift

## Specifications

| MODEL          | OM5-AT                         |
|----------------|--------------------------------|
| Overall width  | 25"                            |
| Overall height | 32" - 36.5"                    |
| Back           | 17.5" w x 16" h (without arms) |
| Seat           | 18" w x 18" d                  |
| Seat height    | 16.5 - 21"                     |
| COM            | .75 yd. seat<br>.75 yd. back   |
| Carton weight  | 32 lbs.                        |
| UPS weight     | 65 lbs.                        |
| Arms           | Optional                       |
| Warranty       | Lifetime Limited               |
| Weight Rating  | 300 lbs.                       |

## Order your chair worksheet

| CATEGORY                | CODE | PRICE |
|-------------------------|------|-------|
| 1. Model                |      |       |
| 2. Arms                 |      |       |
| 3. PolyFlex Shell Color |      |       |
| 4. Back Upholstery      |      |       |
| 5. Seat Upholstery      |      |       |
| 6. Cylinder             |      |       |
| 7. Footring             |      |       |
| 8. Base                 |      |       |
| 9. Casters              |      |       |
| 10. Frame Color/Finish  |      |       |
| 11. Other Options       |      |       |

Unit Price

+ Number of Chairs

= Total Cost for Chairs





# OM5 active tasker

stackable, guest & specialty seating

## 1. Model

| OPTION                                  | CODE          | PRICE    |   |
|---|---------------|----------|---|
| <input type="radio"/> OM5 Active Tasker | <b>OM5-AT</b> | \$298.00 |  |

## 2. Arm Option

| OPTION                          | CODE     | PRICE  |   |
|---------------------------------|----------|--------|---|
| <input type="radio"/> No Arms   | <b>N</b> | + \$0  |  |
| <input type="radio"/> With Arms | <b>A</b> | + \$38 |  |

## 3. PolyFlex Shell Color Option

| OPTION                                       | CODE      | PRICE |
|--|-----------|-------|
| <input type="radio"/> Modern Black (regular) | <b>PB</b> | + \$0 |
| <input type="radio"/> Palladium Grey (reg.)  | <b>PG</b> | + \$0 |
| <input type="radio"/> Arctic White (regular) | <b>PW</b> | + \$0 |
| <input type="radio"/> Mandarin Orange        | <b>PM</b> | + \$0 |
| <input type="radio"/> Sapphire Blue          | <b>PS</b> | + \$0 |
| <input type="radio"/> Aurora Green           | <b>PA</b> | + \$0 |
| <input type="radio"/> Cardinal Red           | <b>PR</b> | + \$0 |

Please contact an OM representative for color chips

## 4. Back Upholstery Option

| OPTION   | CODE                  | PRICE      |
|--|-----------------------|------------|
| <input type="radio"/> Polyflex (unupholstered)                     | <b>PF</b>             | + \$0      |
| <input type="radio"/> Grade 1 / C.O.M.                             | <b>Fabric Color #</b> | + \$38.00  |
| <input type="radio"/> Grade 2 / Grade-in A                         | <b>Fabric Color #</b> | + \$48.00  |
| <input type="radio"/> Grade 3 / Grade-in B                         | <b>Fabric Color #</b> | + \$58.00  |
| <input type="radio"/> Grade 4 / Grade-in C                         | <b>Fabric Color #</b> | + \$68.00  |
| <input type="radio"/> Grade 5 / Grade-in D                         | <b>Fabric Color #</b> | + \$78.00  |
| <input type="radio"/> Grade 6 / Grade-in E                         | <b>Fabric Color #</b> | + \$88.00  |
| <input type="radio"/> Evita leather<br>(Black/White/Stone/Vanilla) | <b>Fabric Color #</b> | + \$100.00 |
| Color #  |                       |            |

## 5. Seat Upholstery Option

| OPTION   | CODE                  | PRICE      |
|--|-----------------------|------------|
| <input type="radio"/> Polyflex (unupholstered)                     | <b>PF</b>             | + \$0      |
| <input type="radio"/> Grade 1 / C.O.M.                             | <b>Fabric Color #</b> | + \$38.00  |
| <input type="radio"/> Grade 2 / Grade-in A                         | <b>Fabric Color #</b> | + \$48.00  |
| <input type="radio"/> Grade 3 / Grade-in B                         | <b>Fabric Color #</b> | + \$58.00  |
| <input type="radio"/> Grade 4 / Grade-in C                         | <b>Fabric Color #</b> | + \$68.00  |
| <input type="radio"/> Grade 5 / Grade-in D                         | <b>Fabric Color #</b> | + \$78.00  |
| <input type="radio"/> Grade 6 / Grade-in E                         | <b>Fabric Color #</b> | + \$88.00  |
| <input type="radio"/> Evita leather<br>(Black/White/Stone/Vanilla) | <b>Fabric Color #</b> | + \$100.00 |
| Color #  |                       |            |

## 6. Cylinder Option

| OPTION                                    | CODE        | PRICE     |
|---|-------------|-----------|
| <input type="radio"/> 5" Black (Standard) | <b>OB5</b>  | + \$0     |
| <input type="radio"/> 5" Chrome           | <b>OC5</b>  | + \$20.00 |
| <b>Stool Package Cylinders</b>            |             |           |
| <input type="radio"/> 8" Chrome           | <b>OC8</b>  | + \$30.00 |
| <input type="radio"/> 10" Chrome          | <b>OC10</b> | + \$30.00 |

## 7. Footring Option

| OPTION                                 | CODE       | PRICE     |   |
|--|------------|-----------|---|
| <input type="radio"/> Without Footring | <b>NTL</b> | + \$0     |  |
| <input type="radio"/> FTG20TL ▲        | <b>TL</b>  | + \$45.00 |   |

## 8. Base Option

| OPTION  | CODE       | PRICE     |   |
|---|------------|-----------|---|
| <input type="radio"/> (STD) 25" Black Base with Carpet Casters                    | <b>B25</b> | + \$0     |    |
| <input type="radio"/> 25" Polished Aluminum with Carpet Casters                   | <b>C25</b> | + \$68.00 |    |
| <b>Stool Package Bases</b>  |            |           |   |
| <input type="radio"/> 27" Black Base ▲ (check notes below)                        | <b>B27</b> | + \$28.00 |   |
| <input type="radio"/> 27" Polished Aluminum Base ▲ (check notes)                  | <b>C27</b> | + \$68.00 |  |
| <input type="radio"/> Fixed Height Chrome Footring and Base (check notes below) ● | <b>GSP</b> | + \$25.56 |  |

## 9. Caster Option

| OPTION   | CODE       | PRICE     |   |
|--|------------|-----------|---|
| <input type="radio"/> Safety Soft Casters                | <b>SS</b>  | + \$25.00 |  |
| <input type="radio"/> Soft Casters (i.e., CAS0065-S)     | <b>SC</b>  | + \$25.00 |  |
| <input type="radio"/> Carpet Casters (default selection) | <b>TC</b>  | + \$0     |  |
| <input type="radio"/> Reverse Braking Casters            | <b>REV</b> | + \$35.00 |  |
| <input type="radio"/> Rubber Casters                     | <b>RUB</b> | + \$25.00 |  |
| <input type="radio"/> Glides                             | <b>G</b>   | + \$0     |  |

## 10. Frame Color/Finish Option

| OPTION                                    | CODE       | PRICE |
|---|------------|-------|
| <input type="radio"/> Black-Powder Coated | <b>BLK</b> | + \$0 |

## 11. Other Options

| OPTION  | CODE          | PRICE  |
|---|---------------|--------|
| <input type="radio"/> Memory Foam (Sub-layer) | <b>UPHCFT</b> | + \$66 |

- ▲ Turn-lock (TL) stool package must be ordered with 8" cylinder or greater, footring, 27" base and soft casters.
  - Grande Spider (GSP) stool package must be ordered with 8" cylinder (only), and soft casters (SC, aka CAS0065-S)
- Visit the OM5 series® learning center at [omsmartseating.com](http://omsmartseating.com) for more available options and up-to-date developments.

# OM5 active stacker

stackable, guest & specialty seating



**OM5-AS Active Stacker**  
example: OM5-AS-A-PM-PF-PF-CHM

## OM5 Active Stacker (AS)

### DESCRIPTION

- One-piece, articulating plastic shell
- OM5 series® Body-Activated motion
- CA TB133-certified (no upcharge)
- Various aesthetic options (i.e., shell color, back/seat upholstery, etc.)
- Stackable, sled-base frame

## Specifications

| MODEL           | OM5-AS                         |
|-----------------|--------------------------------|
| Overall width   | 20.5" (without arms)           |
| Overall height  | 32.5"                          |
| Back            | 17.5" w - 16 h" (without arms) |
| Seat            | 18" w x 18" d                  |
| Seat height     | 18" (fixed)                    |
| COM             | .75 yd. seat<br>.75 yd. back   |
| Carton weight * | 15 lbs.                        |
| UPS weight      | 121 lbs.                       |
| Arms            | Optional                       |
| Warranty        | Lifetime Limited               |
| Weight Rating   | 300 lbs.                       |

\* ships up to 2 per carton (oversize: 3)

## Order your chair worksheet

| CATEGORY                   | CODE | PRICE |
|----------------------------|------|-------|
| 1. Model                   |      |       |
| 2. Arms                    |      |       |
| 3. PolyFlex Shell Color    |      |       |
| 4. Back Upholstery         |      |       |
| 5. Seat Upholstery         |      |       |
| 6. Frame Color/Finish      |      |       |
| 7. Other Options           |      |       |
| Stacking Dolly (Accessory) |      |       |

Unit Price

+ Number of Chairs

= Total Cost for Chairs



# OM5 active stacker

stackable, guest & specialty seating

## 1. Model

| OPTION                                   | CODE          | PRICE    |   |
|--|---------------|----------|---|
| <input type="radio"/> OM5 Active Stacker | <b>OM5-AS</b> | \$238.00 |  |

## 2. Arm Option

| OPTION                                   | CODE     | PRICE  |   |
|--|----------|--------|---|
| <input type="radio"/> No Arms (standard) | <b>N</b> | + \$0  |  |
| <input type="radio"/> With Arms          | <b>A</b> | + \$38 |  |

## 3. PolyFlex Shell Color Option

| OPTION                                       | CODE      | PRICE |
|--|-----------|-------|
| <input type="radio"/> Modern Black (regular) | <b>PB</b> | + \$0 |
| <input type="radio"/> Palladium Grey (reg.)  | <b>PG</b> | + \$0 |
| <input type="radio"/> Arctic White (regular) | <b>PW</b> | + \$0 |
| <input type="radio"/> Mandarin Orange        | <b>PM</b> | + \$0 |
| <input type="radio"/> Sapphire Blue          | <b>PS</b> | + \$0 |
| <input type="radio"/> Aurora Green           | <b>PA</b> | + \$0 |
| <input type="radio"/> Cardinal Red           | <b>PR</b> | + \$0 |

Please contact an OM representative for color chips

## 4. Back Upholstery Option

| OPTION   | CODE                  | PRICE      |
|--|-----------------------|------------|
| <input type="radio"/> Polyflex (unupholstered)                     | <b>PF</b>             | + \$0      |
| <input type="radio"/> Grade 1 / C.O.M.                             | <b>Fabric Color #</b> | + \$38.00  |
| <input type="radio"/> Grade 2 / Grade-in A                         | <b>Fabric Color #</b> | + \$48.00  |
| <input type="radio"/> Grade 3 / Grade-in B                         | <b>Fabric Color #</b> | + \$58.00  |
| <input type="radio"/> Grade 4 / Grade-in C                         | <b>Fabric Color #</b> | + \$68.00  |
| <input type="radio"/> Grade 5 / Grade-in D                         | <b>Fabric Color #</b> | + \$78.00  |
| <input type="radio"/> Grade 6 / Grade-in E                         | <b>Fabric Color #</b> | + \$88.00  |
| <input type="radio"/> Evita leather<br>(Black/White/Stone/Vanilla) | <b>Fabric Color #</b> | + \$100.00 |
| Color #  |                       |            |



## 5. Seat Upholstery Option

| OPTION   | CODE                  | PRICE      |
|--|-----------------------|------------|
| <input type="radio"/> Polyflex (unupholstered)                     | <b>PF</b>             | + \$0      |
| <input type="radio"/> Grade 1 / C.O.M.                             | <b>Fabric Color #</b> | + \$38.00  |
| <input type="radio"/> Grade 2 / Grade-in A                         | <b>Fabric Color #</b> | + \$48.00  |
| <input type="radio"/> Grade 3 / Grade-in B                         | <b>Fabric Color #</b> | + \$58.00  |
| <input type="radio"/> Grade 4 / Grade-in C                         | <b>Fabric Color #</b> | + \$68.00  |
| <input type="radio"/> Grade 5 / Grade-in D                         | <b>Fabric Color #</b> | + \$78.00  |
| <input type="radio"/> Grade 6 / Grade-in E                         | <b>Fabric Color #</b> | + \$88.00  |
| <input type="radio"/> Evita leather<br>(Black/White/Stone/Vanilla) | <b>Fabric Color #</b> | + \$100.00 |
| Color #  |                       |            |

## 6. Frame Color/Finish Option

| OPTION   | CODE       | PRICE |
|--|------------|-------|
| <input type="radio"/> Black-Powder Coated (standard) | <b>BLK</b> | + \$0 |
| <input type="radio"/> Chrome                         | <b>CHM</b> | + \$0 |

## 7. Other Options

| OPTION                                       | CODE          | PRICE     |   |
|--|---------------|-----------|---|
| <input type="radio"/> Memory Foam Sub-layer  | <b>UPHCFT</b> | + \$66.00 |  |
| <input type="radio"/> Book Tray (Black only) | <b>BKTY</b>   | + \$58.00 |  |

## Stacking Dolly (Accessory)

| OPTION  | CODE             | PRICE      |   |
|---|------------------|------------|---|
| <input type="radio"/> OM5 Active Stacking Dolly | <b>STDLY-OM5</b> | + \$358.00 |  |

With Dolly – 20 unupholstered / 14 upholstered  
Without Dolly – 4 unupholstered / 4 upholstered  
(can not stack with BKTY option. CFT option will decrease stackable quantity)

# OM5 active guest

stackable, guest & specialty seating



**OM5-AG Active Guest**  
example: OM5-AG-N-PM-PF-PF-SLR-SG

## OM5 Active Guest (AG)

### DESCRIPTION

- One-piece, articulating plastic shell
- OM5 series® Body-Activated motion
- CA TB133-certified (no upcharge)
- Various aesthetic options (i.e., shell color, back/seat upholstery, etc.)
- Stackable, 4-leg frame

## Specifications

| MODEL           | OM5-AG                         |
|-----------------|--------------------------------|
| Overall width   | 20.75" (without arms)          |
| Overall height  | 33"                            |
| Back            | 17.5" w - 16 h" (without arms) |
| Seat            | 18" w x 18" d                  |
| Seat height     | 18" (fixed)                    |
| COM             | .75 yd. seat<br>.75 yd. back   |
| Carton weight * | 20 lbs.                        |
| UPS weight      | 121 lbs.                       |
| Arms            | Optional                       |
| Warranty        | Lifetime Limited               |
| Weight Rating   | 300 lbs.                       |

\* ships up to 2 per carton (oversize: 3)

## Order your chair worksheet

| CATEGORY                   | CODE | PRICE |
|----------------------------|------|-------|
| 1. Model                   |      |       |
| 2. Arms                    |      |       |
| 3. PolyFlex Shell Color    |      |       |
| 4. Back Upholstery         |      |       |
| 5. Seat Upholstery         |      |       |
| 6. Frame Color/Finish      |      |       |
| 7. Casters                 |      |       |
| 8. Other Options           |      |       |
| Stacking Dolly (Accessory) |      |       |

Unit Price

+ Number of Chairs

= Total Cost for Chairs



# OM5 active guest

stackable, guest & specialty seating

## 1. Model

| OPTION                                 | CODE          | PRICE    |   |
|--|---------------|----------|---|
| <input type="radio"/> OM5 Active Guest | <b>OM5-AG</b> | \$258.00 |  |

## 2. Arm Option

| OPTION  | CODE       | PRICE   |   |
|---|------------|---------|---|
| <input type="radio"/> No Arms (standard)                                | <b>N</b>   | + \$0   |  |
| <input type="radio"/> With Arms   | <b>A</b>   | + \$38  |  |
| <input type="radio"/> Tablet Arm (right-handed only, includes arm pads) | <b>TAB</b> | + \$100 |  |

## 3. PolyFlex Shell Color Option

| OPTION                                       | CODE      | PRICE |
|--|-----------|-------|
| <input type="radio"/> Modern Black (regular) | <b>PB</b> | + \$0 |
| <input type="radio"/> Palladium Grey (reg.)  | <b>PG</b> | + \$0 |
| <input type="radio"/> Arctic White (regular) | <b>PW</b> | + \$0 |
| <input type="radio"/> Mandarin Orange        | <b>PM</b> | + \$0 |
| <input type="radio"/> Sapphire Blue          | <b>PS</b> | + \$0 |
| <input type="radio"/> Aurora Green           | <b>PA</b> | + \$0 |
| <input type="radio"/> Cardinal Red           | <b>PR</b> | + \$0 |

Please contact an OM representative for color chips

## 4. Back Upholstery Option

| OPTION  | CODE                  | PRICE      |
|---|-----------------------|------------|
| <input type="radio"/> Polyflex (unupholstered)                  | <b>Fabric Color #</b> | + \$0      |
| <input type="radio"/> Grade 1 / C.O.M.                          | <b>Fabric Color #</b> | + \$38.00  |
| <input type="radio"/> Grade 2 / Grade-in A                      | <b>Fabric Color #</b> | + \$48.00  |
| <input type="radio"/> Grade 3 / Grade-in B                      | <b>Fabric Color #</b> | + \$58.00  |
| <input type="radio"/> Grade 4 / Grade-in C                      | <b>Fabric Color #</b> | + \$68.00  |
| <input type="radio"/> Grade 5 / Grade-in D                      | <b>Fabric Color #</b> | + \$78.00  |
| <input type="radio"/> Grade 6 / Grade-in E                      | <b>Fabric Color #</b> | + \$88.00  |
| <input type="radio"/> Evita leather (Black/White/Stone/Vanilla) | <b>Fabric Color #</b> | + \$100.00 |
| Color #   |                       |            |

## 5. Seat Upholstery Option

| OPTION  | CODE                  | PRICE      |
|---|-----------------------|------------|
| <input type="radio"/> Polyflex (unupholstered)                  | <b>Fabric Color #</b> | + \$0      |
| <input type="radio"/> Grade 1 / C.O.M.                          | <b>Fabric Color #</b> | + \$38.00  |
| <input type="radio"/> Grade 2 / Grade-in A                      | <b>Fabric Color #</b> | + \$48.00  |
| <input type="radio"/> Grade 3 / Grade-in B                      | <b>Fabric Color #</b> | + \$58.00  |
| <input type="radio"/> Grade 4 / Grade-in C                      | <b>Fabric Color #</b> | + \$68.00  |
| <input type="radio"/> Grade 5 / Grade-in D                      | <b>Fabric Color #</b> | + \$78.00  |
| <input type="radio"/> Grade 6 / Grade-in E                      | <b>Fabric Color #</b> | + \$88.00  |
| <input type="radio"/> Evita leather (Black/White/Stone/Vanilla) | <b>Fabric Color #</b> | + \$100.00 |
| Color #   |                       |            |



## 6. Frame Color/Finish Option

| OPTION   | CODE       | PRICE |
|--|------------|-------|
| <input type="radio"/> Black-Powder Coated (standard) | <b>BLK</b> | + \$0 |
| <input type="radio"/> Silver-Powder Coated           | <b>SLR</b> | + \$0 |

## 7. Caster Option

| OPTION                                     | CODE      | PRICE  |   |
|--|-----------|--------|---|
| <input type="radio"/> Active Glides (std.) | <b>SG</b> | + \$0  |   |
| <input type="radio"/> Active Soft Casters  | <b>AG</b> | + \$15 |  |
| <input type="radio"/> Safety Soft Casters  | <b>SS</b> | + \$25 |  |

## 8. Other Options

| OPTION                                       | CODE          | PRICE     |   |
|--|---------------|-----------|---|
| <input type="radio"/> Memory Foam Sub-layer  | <b>UPHCFT</b> | + \$66.00 |  |
| <input type="radio"/> Book Tray (Black only) | <b>BKTY</b>   | + \$58.00 |  |

## Stacking Dolly (Accessory)

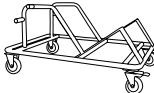
| OPTION  | CODE             | PRICE      |   |
|---|------------------|------------|---|
| <input type="radio"/> OM5 Active Stacking Dolly | <b>STDLY-OM5</b> | + \$358.00 |  |

With Dolly – 15 unupholstered / 9 upholstered  
Without Dolly – 4 unupholstered / 4 upholstered  
(can not stack with TAB or BKTY option. CFT option will decrease stackable quantity)

# OM5 café stool

stackable, guest & specialty seating



**OM5-AC Active Café Stool**  
 (24" or 30" seat heights available)  
 example: OM5-AC-A-PW-PF-PF-CHM30

## OM5 Active Café Stool (AC)

### DESCRIPTION

- One-piece, articulating plastic shell
- OM5 series® Body-Activated motion
- CA TB133-certified (no upcharge)
- Various aesthetic options (i.e., shell color, back/seat upholstery, etc.)
- Stackable, sled-base frame
- Available counter height (24" seat) and bar height (30" seat) frames

## Specifications

| MODEL              | OM5-AC                            |                                   |
|--------------------|-----------------------------------|-----------------------------------|
| Overall width      | 20.5" (without arms)              | 20" (without arms)                |
| Overall height     | 44.5"                             | 38.5"                             |
| Back               | 17.5" w - 16 h"<br>(without arms) | 17.5" w - 16 h"<br>(without arms) |
| Seat               | 18" w x 18" d                     | 18" w x 18" d                     |
| <b>Seat height</b> | <b>30" (fixed, standard)</b>      | <b>24" (fixed)</b>                |
| COM                | .75 yd. seat<br>.75 yd. back      | .75 yd. seat<br>.75 yd. back      |
| Carton weight *    | 22 lbs.                           | 20 lbs.                           |
| UPS weight         | 165 lbs.                          | 165 lbs.                          |
| Arms               | Optional                          | Optional                          |
| Warranty           | Lifetime Limited                  | Lifetime Limited                  |
| Weight Rating      | 300 lbs.                          | 300 lbs.                          |

\* ships up to 2 per carton (oversize: 3)

## Order your chair worksheet

| CATEGORY                | CODE | PRICE |
|-------------------------|------|-------|
| 1. Model                |      |       |
| 2. Arms                 |      |       |
| 3. PolyFlex Shell Color |      |       |
| 4. Back Upholstery      |      |       |
| 5. Seat Upholstery      |      |       |
| 6. Frame Color/Finish   |      |       |
| 7. Other Options        |      |       |

Unit Price

+ Number of Chairs

= Total Cost for Chairs



# OM5 café stool

stackable, guest & specialty seating

## 1. Model

| OPTION                                      | CODE          | PRICE    |   |
|---|---------------|----------|---|
| <input type="radio"/> OM5 Active Café Stool | <b>OM5-AC</b> | \$398.00 |  |

## 2. Arm Option

| OPTION                                   | CODE     | PRICE  |   |
|--|----------|--------|---|
| <input type="radio"/> No Arms (standard) | <b>N</b> | + \$0  |  |
| <input type="radio"/> With Arms          | <b>A</b> | + \$38 |  |

## 3. PolyFlex Shell Color Option

| OPTION                                       | CODE      | PRICE |
|--|-----------|-------|
| <input type="radio"/> Modern Black (regular) | <b>PB</b> | + \$0 |
| <input type="radio"/> Palladium Grey (reg)   | <b>PG</b> | + \$0 |
| <input type="radio"/> Arctic White (regular) | <b>PW</b> | + \$0 |
| <input type="radio"/> Mandarin Orange        | <b>PM</b> | + \$0 |
| <input type="radio"/> Sapphire Blue          | <b>PS</b> | + \$0 |
| <input type="radio"/> Aurora Green           | <b>PA</b> | + \$0 |
| <input type="radio"/> Cardinal Red           | <b>PR</b> | + \$0 |

Please contact an OM representative for color chips

## 4. Back Upholstery Option

| OPTION   | CODE                  | PRICE      |
|--|-----------------------|------------|
| <input type="radio"/> Polyflex (unupholstered)                     | <b>Fabric Color #</b> | + \$0      |
| <input type="radio"/> Grade 1 / C.O.M.                             | <b>Fabric Color #</b> | + \$38.00  |
| <input type="radio"/> Grade 2 / Grade-in A                         | <b>Fabric Color #</b> | + \$48.00  |
| <input type="radio"/> Grade 3 / Grade-in B                         | <b>Fabric Color #</b> | + \$58.00  |
| <input type="radio"/> Grade 4 / Grade-in C                         | <b>Fabric Color #</b> | + \$68.00  |
| <input type="radio"/> Grade 5 / Grade-in D                         | <b>Fabric Color #</b> | + \$78.00  |
| <input type="radio"/> Grade 6 / Grade-in E                         | <b>Fabric Color #</b> | + \$88.00  |
| <input type="radio"/> Evita leather<br>(Black/White/Stone/Vanilla) | <b>Fabric Color #</b> | + \$100.00 |

Color #

## 5. Seat Upholstery Option



| OPTION   | CODE                  | PRICE      |
|--|-----------------------|------------|
| <input type="radio"/> Polyflex (unupholstered)                     | <b>Fabric Color #</b> | + \$0      |
| <input type="radio"/> Grade 1 / C.O.M.                             | <b>Fabric Color #</b> | + \$38.00  |
| <input type="radio"/> Grade 2 / Grade-in A                         | <b>Fabric Color #</b> | + \$48.00  |
| <input type="radio"/> Grade 3 / Grade-in B                         | <b>Fabric Color #</b> | + \$58.00  |
| <input type="radio"/> Grade 4 / Grade-in C                         | <b>Fabric Color #</b> | + \$68.00  |
| <input type="radio"/> Grade 5 / Grade-in D                         | <b>Fabric Color #</b> | + \$78.00  |
| <input type="radio"/> Grade 6 / Grade-in E                         | <b>Fabric Color #</b> | + \$88.00  |
| <input type="radio"/> Evita leather<br>(Black/White/Stone/Vanilla) | <b>Fabric Color #</b> | + \$100.00 |

Color #

## 6. Frame Color/Finish Option

| OPTION  | CODE         | PRICE |
|---|--------------|-------|
| <input type="radio"/> Chrome (30" Seat Ht.)<br>(standard) | <b>CHM30</b> | + \$0 |
| <input type="radio"/> Chrome (24" Seat Ht.)               | <b>CHM24</b> | + \$0 |

## 7. Other Options

| OPTION   | CODE          | PRICE     |   |
|--|---------------|-----------|---|
| <input type="radio"/> Memory Foam<br>Sub-layer | <b>UPHCFT</b> | + \$66.00 |  |
| <input type="radio"/> Book Tray (Black only)   | <b>BKTY</b>   | + \$58.00 |  |





specialty

# classic specialty stools (CL)

## features:

Begins @ \$278 in Grade 1 upholstery

CLFT, CLVS – Specialized designs for foot support, filing or other low height-oriented tasks

→  
Use our  
handy  
stickers to  
mark this  
section.

classic  
specialty stools  
(CL)



**CLVS**  
\$308 List (as shown)



**CLFT**  
\$338 List (as shown)

# classic specialty stools (CL)

stackable, guest & specialty seating

Please see page 149 for some relevant upholstery options.

specialty stools

| Model | Description                         | Textile Grade-In     | List     | Specifications           |
|-------|-------------------------------------|----------------------|----------|--------------------------|
| CLFT  | Pneumatic lift                      | Grade 1 / C.O.M.     | \$278.00 | Overall width 19"        |
|       | Chrome base                         | Grade 2 / Grade-in A | \$293.00 | Overall height 13" - 16" |
|       | Tilting seat                        | Grade 3 / Grade-in B | \$308.00 | Back N/A                 |
|       | Memory foam layer in cushion        | Grade 4 / Grade-in C | \$323.00 | Seat 19" w x 18" d       |
|       | 3" travel range cylinder (standard) | Grade 5 / Grade-in D | \$338.00 | Seat height 13" - 17"    |
|       | Safety soft casters (standard)      | Grade 6 / Grade-in E | \$353.00 | COM .75 yd.              |
|       |                                     |                      |          | Carton weight 26 pounds  |
|       |                                     |                      |          | UPS weight 33 pounds     |
|       |                                     |                      |          | Arms N/A                 |
|       |                                     |                      |          | Warranty 12 year limited |



| Model | Description                    | Textile Grade-In     | List     | Specifications           |
|-------|--------------------------------|----------------------|----------|--------------------------|
| CLVS  | Pneumatic lift                 | Grade 1 / C.O.M.     | \$278.00 | Overall width 19"        |
|       | Chrome base                    | Grade 2 / Grade-in A | \$293.00 | Overall height 16" - 23" |
|       | Tilting seat                   | Grade 3 / Grade-in B | \$308.00 | Back N/A                 |
|       | CYL-6-SHD cylinder (standard)  | Grade 4 / Grade-in C | \$323.00 | Seat 18" w x 17" d       |
|       | Safety soft casters (standard) | Grade 5 / Grade-in D | \$338.00 | Seat height 16" - 23"    |
|       |                                | Grade 6 / Grade-in E | \$353.00 | COM .75 yd.              |
|       |                                |                      |          | Carton weight 26 pounds  |
|       |                                |                      |          | UPS weight 33 pounds     |
|       |                                |                      |          | Arms N/A                 |
|       |                                |                      |          | Warranty 12 year limited |



stackable | guest  
specialty seating

# stackable guest series (SG)

## features:

Begins @ \$135 armless (SG300) / \$165 with arms (SG3A)

Contemporary design stackable guest seating ideal for any occasional use environment

Tapered legs with self-leveling glides

→  
Use our  
handy  
stickers to  
mark this  
section.  
stackable  
guest series  
(SG)



### **SG2K**

Pictured here in optional Grade 2  
Chess Queen upholstery  
\$191 List (as shown)

# stackable guest series (SG)

stackable, guest & specialty seating

perforated plastic back

| Model <b>[NEW]</b> | Description  | Textile Grade-In                  | List     | Specifications           |
|--------------------|--|-----------------------------------|----------|--------------------------|
| SG1K               | Cushion seat   | Grade 1 / C.O.M.                  | \$174.00 | Overall width 25"        |
|                    | Perforated black plastic back                                | Grade 2                           | \$184.00 | Overall height 34"       |
|                    | Armless  | Grade 3 / Grade-in A              | \$194.00 | Back 19" w x 16" h       |
|                    | Carpet casters on all 4 legs (default)                       | Grade 4 / Grade-in B              | \$204.00 | Seat 19" w x 20" d       |
|                    |  | Grade 5 / Grade-in C              | \$214.00 | Seat height 18"          |
|                    | Stack up to 4 without dolly<br>(No dolly available for SG1K) | Grade 6 / Grade-in D              | \$224.00 | COM .75 yd./per 2 chairs |
|                    |  | Upholstered back add \$35 to list |          | Carton weight 19 pounds  |
|                    |  |                                   |          | UPS weight 104 pounds    |
|                    |  |                                   |          | Arms N/A                 |
|                    |  |                                   |          | Warranty 7 year limited  |



*Ships with back detached when more than 1, up to 2 per carton, but may vary. Call OM for details.*

| Model | Description  | Textile Grade-In                  | List     | Specifications           |
|-------|--|-----------------------------------|----------|--------------------------|
| SG2K  | Cushion seat   | Grade 1 / C.O.M.                  | \$181.00 | Overall width 25"        |
|       | Perforated black plastic back                                | Grade 2                           | \$191.00 | Overall height 34"       |
|       | Neo-classic arm design                                       | Grade 3 / Grade-in A              | \$201.00 | Back 19" w x 16" h       |
|       | Rear casters/front glides                                    | Grade 4 / Grade-in B              | \$211.00 | Seat 19" w x 20" d       |
|       |  | Grade 5 / Grade-in C              | \$221.00 | Seat height 18"          |
|       | Stack up to 4 without dolly<br>(No dolly available for SG2K) | Grade 6 / Grade-in D              | \$231.00 | COM .75 yd./per 2 chairs |
|       |  | Upholstered back add \$35 to list |          | Carton weight 20 pounds  |
|       |  |                                   |          | UPS weight 104 pounds    |
|       |  |                                   |          | Arms Included            |
|       |  |                                   |          | Warranty 7 year limited  |



*Ships with back detached when more than 1, up to 2 per carton, but may vary. Call OM for details.*

stackable, guest & specialty seating

# stackable guest series (SG)

contoured plastic back

| Model | Description                 | Textile Grade-In    | List     | Specifications          |
|-------|-----------------------------|---------------------|----------|-------------------------|
| SG300 | Graphite-color seat/back    | Black polypropylene | \$135.00 | Overall width 21"       |
|       | Titanium-color tapered legs |                     |          | Overall height 32"      |
|       | Wall-saving design          |                     |          | Back 19" w x 16" h      |
|       | Contoured molded seat       |                     |          | Seat 18" w x 19" d      |
|       | Self-leveling glides        |                     |          | Seat height 17"         |
|       |                             |                     |          | COM N/A                 |
|       | Stack up to 5 without dolly |                     |          | Carton weight 16 pounds |
|       |                             |                     |          | UPS weight 104 pounds   |
|       |                             |                     |          | Arms N/A                |
|       |                             |                     |          | Warranty 7 year limited |



| Model | Description                 | Textile Grade-In    | List     | Specifications           |
|-------|-----------------------------|---------------------|----------|--------------------------|
| SG3A  | Graphite-color seat/back    | Black polypropylene | \$165.00 | Overall width 23"        |
|       | Titanium-color tapered legs |                     |          | Overall height 32"       |
|       | Wall-saving design          |                     |          | Back 19" w x 16" h       |
|       | Contoured molded seat       |                     |          | Seat 18" w x 19" d       |
|       | Outboard arm design         |                     |          | Seat height 17"          |
|       | Self-leveling glides        |                     |          | COM .75 yd./per 2 chairs |
|       | Stack up to 5 without dolly |                     |          | Carton weight 19 pounds  |
|       |                             |                     |          | UPS weight 104 pounds    |
|       |                             |                     |          | Arms Included            |
|       |                             |                     |          | Warranty 7 year limited  |



| Model | Description                 | Textile Grade-In     | List     | Specifications          |
|-------|-----------------------------|----------------------|----------|-------------------------|
| SG3B  | Graphite-color seat/back    | Grade 1 / C.O.M.     | \$193.00 | Overall width 23"       |
|       | Titanium-color tapered legs | Grade 2              | \$208.00 | Overall height 32"      |
|       | Wall-saving design          | Grade 3 / Grade-in A | \$223.00 | Back 19" w x 16" h      |
|       | Contoured molded seat       | Grade 4 / Grade-in B | \$238.00 | Seat 18" w x 19" d      |
|       | Cushion seat/back           | Grade 5 / Grade-in C | \$253.00 | Seat height 18"         |
|       | Outboard arm design         | Grade 6 / Grade-in D | \$268.00 | COM .75 yd.             |
|       | Self-leveling glides        |                      |          | Carton weight 22 pounds |
|       | Stack up to 4 without dolly |                      |          | UPS weight 104 pounds   |
|       |                             |                      |          | Arms Included           |
|       |                             |                      |          | Warranty 7 year limited |



| Model | Description                 | Textile Grade-In     | List     | Specifications          |
|-------|-----------------------------|----------------------|----------|-------------------------|
| SG3C  | Graphite-color seat/back    | Grade 1 / C.O.M.     | \$181.00 | Overall width 21"       |
|       | Titanium-color tapered legs | Grade 2              | \$196.00 | Overall height 32"      |
|       | Wall-saving design          | Grade 3 / Grade-in A | \$211.00 | Back 19" w x 16" h      |
|       | Contoured molded seat       | Grade 4 / Grade-in B | \$226.00 | Seat 18" w x 19" d      |
|       | Cushion seat/back           | Grade 5 / Grade-in C | \$241.00 | Seat height 18"         |
|       | Self-leveling glides        | Grade 6 / Grade-in D | \$256.00 | COM .75 yd.             |
|       | Stack up to 4 without dolly |                      |          | Carton weight 21 pounds |
|       |                             |                      |          | UPS weight 104 pounds   |
|       |                             |                      |          | Arms N/A                |
|       |                             |                      |          | Warranty 7 year limited |



onsmartseating.com

SMART SEATING



Upholstery option for meeting CA-Technical Bulletin-133 NOT available on ST/SG Series stacking chairs. ; UPS weight is calculated using UPS dimensional standards to determine billable weight. ; Pricing and specifications subject to change without notification.

# stackable guest series (SG)

stackable, guest & specialty seating

contoured plastic back

## Model

SG3W



300  
POUNDS  
CAPACITY

## Description

Graphite-color back  
Graphite-color arms  
Titanium-color tapered legs  
Wall-saving design  
Molded seat cushion  
Molded back cushion  
Self-leveling glides

Stack up to 3 without dolly

## Textile Grade-In

Grade 1 / C.O.M. \$224.00  
Grade 2 \$239.00  
Grade 3 / Grade-in A \$254.00  
Grade 4 / Grade-in B \$269.00  
Grade 5 / Grade-in C \$284.00  
Grade 6 / Grade-in D \$299.00

## List

## Specifications

Overall width 23"  
Overall height 32"  
Back 19" w x 16" h  
Seat 19" w x 20" d  
Seat height 18"  
COM 1 yd.  
Carton weight 23 pounds  
UPS weight 104 pounds  
Arms Included  
Warranty 7 year limited

mesh back

## Model

SG5K



## Description

Graphite-color seat/back  
Titanium-color tapered legs  
Wall-saving design  
Contoured molded seat  
Outboard arm design  
Carpet casters on all 4 legs (default)

Stack up to 5 without dolly  
(No dolly available for SG5K)

## Textile Grade-In

Grade 1 / C.O.M. \$278.00  
Grade 2 \$288.00  
Grade 3 / Grade-in A \$298.00  
Grade 4 / Grade-in B \$308.00  
Grade 5 / Grade-in C \$318.00  
Grade 6 / Grade-in D \$328.00

## List

## Specifications

Overall width 25.5"  
Overall height 36.5"  
Back 21" w x 19" h  
Seat 18" w x 18" d  
Seat height 18"  
COM .75 yd./per 2 chairs  
Carton weight 20 pounds  
UPS weight 28 pounds  
Arms Included  
Warranty 7 year limited

common options

## Suggested Options

### Dolly

**STDLY3** - list: 198.00

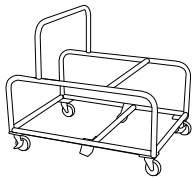

### Description

Storage Dolly

Lockable casters  
Steel frame  
Stacks up to 10 upholstered SG3x chairs  
Stacks up to 12 non-upholstered SG3 Series chairs (e.g. SG300 & SG3A but excluding SG1K, SG2K, & SG5K)

*Sold at discount in near new condition*

### Specifications

Overall length 31"  
Overall width 22.5"  
Overall height 27"  
UPS weight 20 pounds\*  
Warranty 7 year limited

### Ganging

**SGGANG** - list: 12.00  
(per set of 2)



### Description

Ganging Device

Sold in pairs  
One pair required to gang two chairs  
Feature for SG3x Chairs only

### Specifications

Overall length 6.25"  
Overall width 1.5"  
Overall height 1"

\*Consult with an OM representative for weights and questions related to shipping storage dollies.

stackable | guest  
specialty seating

# stacking chair series (ST)

## features:

Begins @ \$94 armless / \$143 with SR-40 arms (ST400)

Sled-base higher density stacking chairs for any occasional use environment

Simple, budget-oriented design and appeal

Easy to set up and store away



### **ST200/ST200C**

Pictured on right in optional Grade 3  
Sahara Cactus Upholstery  
\$100.00 / \$152.00 List (respectively)



### **ST400**

Pictured here unupholstered  
\$94.00 List



### **ST400F**

Pictured here in optional Grade 3  
Stage Shrek Upholstery  
Optional SR-40 Arms  
\$242.00 List

→  
Mark the  
section  
with this  
handy tab.  
stacking chair  
series (ST)

# stacking chair series (ST)

stackable, guest & specialty seating

perforated plastic back

## Model

### ST200



## Description

Black plastic seat  
Black plastic back  
Silver powder coat frame  
Integrated ganging device

Stack up to 6 without dolly

## Textile Grade-In

Black Plastic \$100.00  
Upholstered back add \$35 to list

## List

## Specifications

Overall width 22"  
Overall height 34"  
Back 19" w x 16" h  
Seat 18" w x 19" d  
Seat height 17.5"  
COM N/A  
Carton weight 15 pounds  
UPS weight 104 pounds/per carton  
Arms N/A  
Warranty 7 year limited

*Ships with back detached when more than 1, up to 3 per carton, but may vary. Call OM for details.*

## Model

### ST200C



## Description

Upholstered seat  
Black plastic back  
Silver powder coat frame  
Integrated ganging device

Stack up to 5 without dolly

(Recommended: Stack from front, rather than above.)

## Textile Grade-In

Grade 1 / C.O.M. \$132.00  
Grade 2 \$142.00  
Grade 3 / Grade-in A \$152.00  
Grade 4 / Grade-in B \$162.00  
Grade 5 / Grade-in C \$172.00  
Grade 6 / Grade-in D \$182.00  
Upholstered back add \$35 to list

## List

## Specifications

Overall width 22"  
Overall height 34"  
Back 19" w x 16" h  
Seat 19" w x 20" d  
Seat height 18"  
COM .75 yd./per 2 chairs  
Carton weight 16 pounds  
UPS weight 104 pounds/per carton  
Arms N/A  
Warranty 7 year limited

*Ships with back detached when more than 1, up to 3 per carton, but may vary. Call OM for details.*

contoured plastic back

## Model

### ST400



## Description

Black plastic seat  
Black plastic back  
Silver powder coat frame

Stack up to 5 without dolly  
Stack up to 25 with dolly

## Textile Grade-In

Black Plastic \$94.00

## List

## Specifications

Overall width 21"  
Overall height 32"  
Back 19" w x 16" h  
Seat 18" w x 18" d  
Seat height 17.5"  
COM N/A  
Carton weight 10 pounds  
UPS weight 104 pounds/per carton  
Arms N/A  
Warranty 7 year limited

*Order in multiples of 3 chairs, otherwise additional carton charge will be applied.*

*Ships up to 3 per carton, but may vary. Call OM for details.*

## Model

### ST-400F



## Description

Upholstered seat  
Upholstered back  
Silver powder coat frame

Stack up to 4 without dolly  
Stack up to 15 with dolly

## Textile Grade-In

Grade 1 / C.O.M. \$153.00  
Grade 2 \$163.00  
Grade 3 / Grade-in A \$173.00  
Grade 4 / Grade-in B \$183.00  
Grade 5 / Grade-in C \$193.00  
Grade 6 / Grade-in D \$203.00

## List

## Specifications

Overall width 21"  
Overall height 32"  
Back 19" w x 16" h  
Seat 18" w x 18" d  
Seat height 18"  
COM .75 yd./per 2 chairs  
Carton weight 11 pounds  
UPS weight 104 pounds/per carton  
Arms N/A  
Warranty 7 year limited

*Order in multiples of 3 chairs, otherwise additional carton charge will be applied.*

*Ships up to 3 per carton, but may vary. Call OM for details.*

**NOTE** When ordering an ST400 with the upholstery option, select a fabric color first and then use that fabric's color number to fill in the space after "ST-\_\_\_" (example: ST-1004 is an ST400 chair upholstered with Basic no. 1004 Navy).

**DESIGN STATEMENT** Very easy to set up and so convenient to store away. A wide range of stacking chair lines makes OM a one-stop provider for all your seating needs. 400 Series stacking chairs are the long-awaited update to our popular and affordable 100 Series stackers.



stackable, guest & specialty seating

# stacking chair series (ST)

common options

## Suggested Options

Dolly

**STDLY2** - list: \$110.00

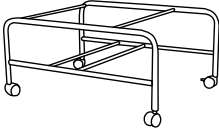

**Description** Storage Dolly  
 Lockable casters  
 Black finish steel frame  
 Stacks up to 20 ST200 chairs  
 Stacks up to 12 ST200C chairs

*Sold at discount in near new condition*

**Specifications**  
 Overall length 32"  
 Overall width 25"  
 Overall height 16"  
 UPS weight 30 pounds\*  
 Warranty 7 year limited

**STDLY4** - list: \$110.00

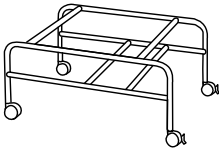

**Description** Storage Dolly  
 Lockable casters  
 Steel frame  
 Stacks up to 15 ST400F chairs  
 Stacks up to 25 ST400 chairs

*Sold at discount in near new condition*

**Specifications**  
 Overall length 34"  
 Overall width 23.5"  
 Overall height 15"  
 UPS weight 15 pounds\*  
 Warranty 7 year limited

Arm

**SR-40** - list: \$49.00  
 (a pair)



**Description** Arms  
 Sold in pairs (black arm pad, silver frame)  
 Each pair contains one left arm and one right arm  
 Feature for ST400 Series chairs only  
 Adds approximately 1.75" to each side on overall width for ST400 Series

**Specifications**  
 Overall length 11"

\*Consult with an OM representative for weights and questions related to shipping storage dollies.



## features:

Begins @ \$191 armless (WS10)

Low-maintenance and straightforward seating for shop and dirtier environments

Self-skinned polyurethane seat/back makes for easy cleaning

Variety of optional styles, including "Sit-Stand" stools



**WS23**

\$276.00 List (as shown)



**WS15**

\$264.00 List (as shown)

→  
Use our  
handy  
stickers to  
mark this  
section.

workstools  
(WS)

# worktools (WS)

stackable, guest & specialty seating

Please see pages 119 and 146 for options.

utility seats

| Model | Description    | Textile Grade-In   | List     | Specifications |                |
|-------|----------------|--------------------|----------|----------------|----------------|
| WS10  | Pneumatic lift | Black polyurethane | \$191.00 | Overall width  | 25"            |
|       |                |                    |          | Overall height | 21" - 26"      |
|       |                |                    |          | Back           | N/A            |
|       |                |                    |          | Seat           | 15" w x 13" d  |
|       |                |                    |          | Seat height    | 16" - 21"      |
|       |                |                    |          | COM            | N/A            |
|       |                |                    |          | Carton weight  | 25 pounds      |
|       |                |                    |          | UPS weight     | 33 pounds      |
|       |                |                    |          | Arms           | N/A            |
|       |                |                    |          | Warranty       | 7 year limited |



| Model | Description                 | Textile Grade-In   | List     | Specifications |                |
|-------|-----------------------------|--------------------|----------|----------------|----------------|
| WS11  | Pneumatic lift<br>Tool tray | Black polyurethane | \$217.00 | Overall width  | 25"            |
|       |                             |                    |          | Overall height | 21" - 26"      |
|       |                             |                    |          | Back           | N/A            |
|       |                             |                    |          | Seat           | 15" w x 13" d  |
|       |                             |                    |          | Seat height    | 16" - 21"      |
|       |                             |                    |          | COM            | N/A            |
|       |                             |                    |          | Carton weight  | 28 pounds      |
|       |                             |                    |          | UPS weight     | 33 pounds      |
|       |                             |                    |          | Arms           | N/A            |
|       |                             |                    |          | Warranty       | 7 year limited |



| Model | Description                    | Textile Grade-In   | List     | Specifications |                |
|-------|--------------------------------|--------------------|----------|----------------|----------------|
| WS12  | Pneumatic lift<br>Tilting seat | Black polyurethane | \$216.00 | Overall width  | 25"            |
|       |                                |                    |          | Overall height | 22" - 27"      |
|       |                                |                    |          | Back           | N/A            |
|       |                                |                    |          | Seat           | 15" w x 13" d  |
|       |                                |                    |          | Seat height    | 17" - 22"      |
|       |                                |                    |          | COM            | N/A            |
|       |                                |                    |          | Carton weight  | 25 pounds      |
|       |                                |                    |          | UPS weight     | 33 pounds      |
|       |                                |                    |          | Arms           | N/A            |
|       |                                |                    |          | Warranty       | 7 year limited |





stackable, guest & specialty seating



# workstools (WS)

Please see pages 119 and 146 for options.

utility seats

| Model   | Description  | Sit/Stand Stool | Textile Grade-In   | List     | Specifications               |
|---|--|-----------------|--------------------|----------|------------------------------|
| WS15  | Pneumatic lift   |                 | Black polyurethane | \$264.00 | Overall width 23"            |
|   | Tilting seat   |                 |                    |          | Overall height 28.5" - 38.5" |
|  | Unibody ring base                                      |                 |                    |          | Back N/A                     |
|   | Glides   |                 |                    |          | Seat 15" w x 13" d           |
|   | Optional 8" chrome cylinder available (approx. 19-27") |                 |                    |          | Seat height 22" - 32"        |
|   |  |                 |                    |          | COM N/A                      |
|   |  |                 |                    |          | Carton weight 30 pounds      |
|   |  |                 |                    |          | UPS weight 33 pounds         |
|   |  |                 |                    |          | Arms N/A                     |
|   |  |                 |                    |          | Warranty 7 year limited      |

| Model   | Description  | Textile Grade-In     | List     | Specifications               |
|---|--|----------------------|----------|------------------------------|
| WS15VS  | Pneumatic lift   | Grade 1 / C.O.M.     | \$278.00 | Overall width 23"            |
|   | Tilting seat   | Grade 2 / Grade-in A | \$293.00 | Overall height 28.5" - 38.5" |
|  | Unibody ring base                                      | Grade 3 / Grade-in B | \$308.00 | Back N/A                     |
|   | Glides   | Grade 4 / Grade-in C | \$323.00 | Seat 19.5" w x 19" d         |
|   | Upholstered seat                                       | Grade 5 / Grade-in D | \$338.00 | Seat height 24" - 34"        |
|   | Optional 8" chrome cylinder available (approx. 19-27") | Grade 6 / Grade-in E | \$353.00 | COM 1 yd.                    |
|   |  |                      |          | Carton weight 31 pounds      |
|   |  |                      |          | UPS weight 33 pounds         |
|   |  |                      |          | Arms N/A                     |
|   |  |                      |          | Warranty 7 year limited      |

| Model   | Description  | Textile Grade-In  | List     | Specifications            |
|---|--|---|----------|---------------------------|
| WS16  | Pneumatic lift   | Black polyurethane  | \$258.00 | Overall width 23"         |
|   | Extra wide tilting seat                                |   |          | Overall height 26" - 36"  |
|  | Unibody ring base                                      |   |          | Back N/A                  |
|   | Glides   |   |          | Seat 17" w x 16" d        |
|   | Convenient carry handle                                |  |          | Seat height 22.5" - 32.5" |
|   | Optional 8" chrome cylinder available (approx. 19-27") |   |          | COM N/A                   |
|   |  |   |          | Carton weight 31 pounds   |
|   |  |   |          | UPS weight 33 pounds      |
|   |  |   |          | Arms N/A                  |
|   |  |   |          | Warranty 7 year limited   |

**NOTE** For customers who prefer an upholstered seat cushion on the basic frame of the WS15, the seat of the CLVS is available in model WS15VS.

WS15, WS15VS & WS16 can be upgraded to any size standard cylinder see page 147.

# workstools (WS)

stackable, guest & specialty seating

Please see pages 119 and 146 for options.

utility chairs & stools

| Model | Description            | Textile Grade-In             | List     | Specifications           |
|-------|------------------------|------------------------------|----------|--------------------------|
| WS22  | Pneumatic lift         | Black polyurethane (armless) | \$228.00 | Overall width 25"        |
|       | Pivot backrest         | With BR-2 arms               | \$274.00 | Overall height 29" - 34" |
|       | Back height adjustment | with BR-5 arms               | \$283.00 | Back 15.5" w x 12.5" h   |
|       | Back depth adjustment  |                              |          | Seat 17" w x 16" d       |
|       |                        |                              |          | Seat height 16" - 21"    |
|       |                        |                              |          | COM N/A                  |
|       |                        |                              |          | Carton weight 34 pounds  |
|       |                        |                              |          | UPS weight 34 pounds     |
|       |                        |                              |          | Arms Group BC            |
|       |                        |                              |          | Warranty 7 year limited  |



| Model | Description            | Textile Grade-In             | List     | Specifications           |
|-------|------------------------|------------------------------|----------|--------------------------|
| WS23  | Pneumatic lift         | Black polyurethane (armless) | \$276.00 | Overall width 25"        |
|       | Pivot backrest         | With BR-2 arms               | \$322.00 | Overall height 35" - 45" |
|       | Back height adjustment | with BR-5 arms               | \$331.00 | Back 15.5" w x 12.5" h   |
|       | Back depth adjustment  |                              |          | Seat 17" w x 16" d       |
|       | 20" black footring     |                              |          | Seat height 21" - 31"    |
|       |                        |                              |          | COM N/A                  |
|       |                        |                              |          | Carton weight 40 pounds  |
|       |                        |                              |          | UPS weight 40 pounds     |
|       |                        |                              |          | Arms Group BC            |
|       |                        |                              |          | Warranty 7 year limited  |



| Model | Description            | Textile Grade-In             | List     | Specifications           |
|-------|------------------------|------------------------------|----------|--------------------------|
| WS24  | Pneumatic lift         | Black polyurethane (armless) | \$264.00 | Overall width 25"        |
|       | Pivot backrest         | With BR-2 arms               | \$310.00 | Overall height 30" - 35" |
|       | Back height adjustment | with BR-5 arms               | \$319.00 | Back 15.5" w x 12.5" h   |
|       | Tilting backrest       |                              |          | Seat 17" w x 16" d       |
|       | Tilting seat           |                              |          | Seat height 16" - 21"    |
|       |                        |                              |          | COM N/A                  |
|       |                        |                              |          | Carton weight 35 pounds  |
|       |                        |                              |          | UPS weight 35 pounds     |
|       |                        |                              |          | Arms Group BC            |
|       |                        |                              |          | Warranty 7 year limited  |



| Model | Description            | Textile Grade-In             | List     | Specifications           |
|-------|------------------------|------------------------------|----------|--------------------------|
| WS25  | Pneumatic lift         | Black polyurethane (armless) | \$313.00 | Overall width 26"        |
|       | Pivot backrest         | With BR-2 arms               | \$359.00 | Overall height 36" - 49" |
|       | Back height adjustment | with BR-5 arms               | \$368.00 | Back 15.5" w x 12.5" h   |
|       | Tilting backrest       |                              |          | Seat 17" w x 16" d       |
|       | 20" black footring     |                              |          | Seat height 22" - 32"    |
|       | Tilting seat           |                              |          | COM N/A                  |
|       |                        |                              |          | Carton weight 42 pounds  |
|       |                        |                              |          | UPS weight 42 pounds     |
|       |                        |                              |          | Arms Group BC            |
|       |                        |                              |          | Warranty 7 year limited  |









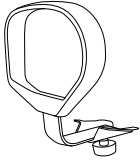

omsmartseating.com

SMART SEATING

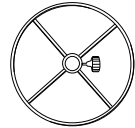

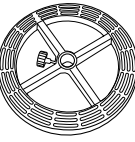
common options

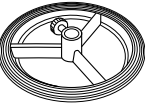
**Suggested Options for Workstools WS22-WS25**

|   |  |  |  |
|---|--|--|--|
| <p><b>Arms kits</b></p>  | <p><b>BR-2</b> - list: 46.00<br/>Width adjustable loop arms<br/>Adjustable with range of 2.5"<br/>7 year limited warranty*</p>   |     | <p><b>BR-85</b> - list: 40.00<br/>Fixed loop arms<br/>Fits BC85 chair<br/>7 year limited warranty</p>  |
|                          | <p><b>BR-5</b> - list: 55.00<br/>Height &amp; width adjustable T-arms<br/>Adjustable height range of 2.5"<br/>Adjustable width range of 2.5"<br/>7 year limited warranty*<br/>Note: Version for BC85 is available upon request</p> |  |  |
| <p><b>Options</b></p>    | <p><b>FTGBC41</b> - list: 16.00 (upcharge), 59.00 (buy)<br/>18" chrome footring for BC, CL and WS<br/>(or exchange with black plastic footring)</p>  |    | <p><b>CYL-4M</b> - list: 13.00 (upcharge), 88.00 (buy)<br/>4" cylinder for BC chairs (minimum height lowered by 1", changes range to 4")</p> |
|                          | <p><b>FTG20PL</b> - list: 16.00 (upcharge), 59.00 (buy)<br/>20" black plastic footring for BC and WS<br/>(or exchange with chrome footring)</p>  |    | <p><b>CYL-5M</b> - list: 13.00 (upcharge), 73.00 (buy)<br/>5" cylinder for most of BC task and executive chairs</p>                          |
|                        | <p><b>TLTRAY</b> - list: N/A (upcharge), 43.00 (buy)<br/>Tool tray fits WS Series workstools and other chairs (check with OM for compatibility)</p>  |  | <p><b>CYL-10M</b> - list: N/A (upcharge), 102.00 (buy)<br/>10" cylinder: standard cylinder for BC drafting stools (range of 23-33")</p>      |

Above weights do not include optional arm kits. \* UPS weight is calculated using UPS dimensional standards to determine billable weight. † Pricing and specifications subject to change without notification.





# OM company information

## features:

About OM

OM Terms & conditions

Warranty

GSA Terms & conditions

“Sustainable environmentalism”

BIFMA Test for fit

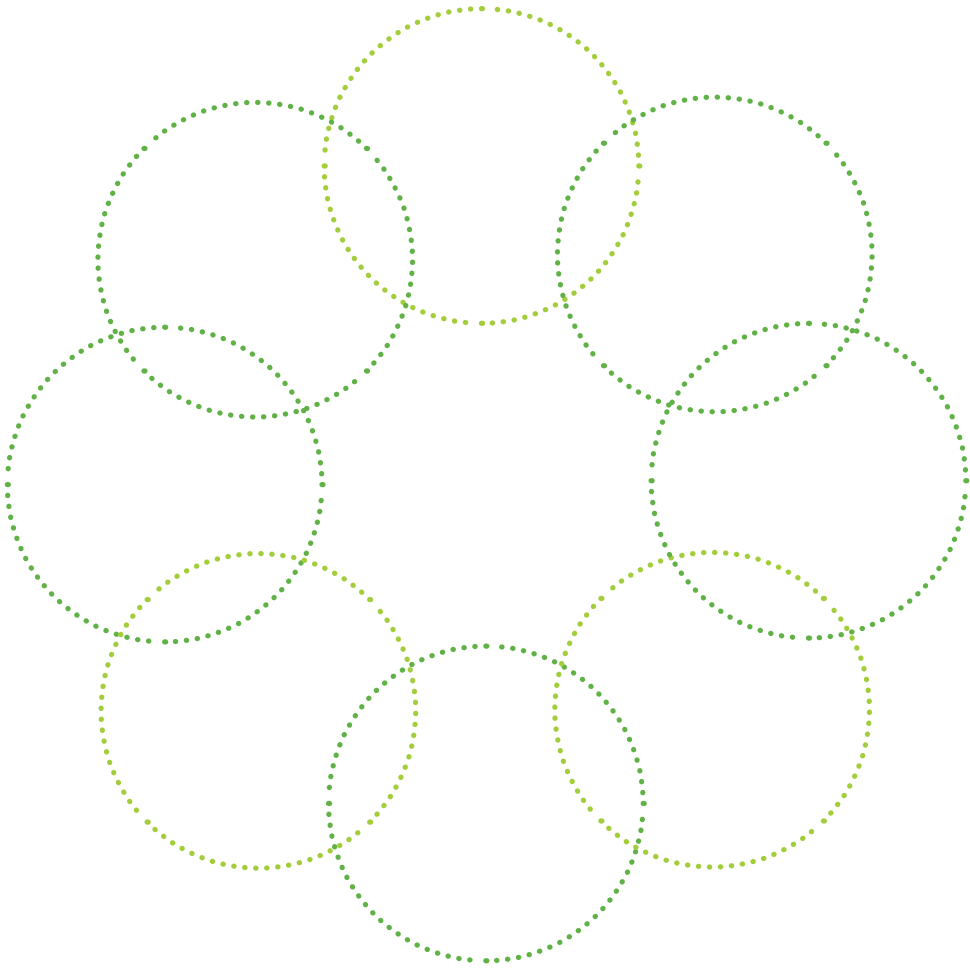

→  
Use our  
handy  
stickers to  
mark this  
section.

OM company  
information

# about om

## **The Company**

OM is known for excellence in function. With a single focus on seating, and only seating, OM offers a broad and deep understanding of what makes a chair work. Whatever the environment, and whatever the purpose, an OM chair will suit your needs. By focusing exclusively on ergonomic and well-thought-out seating, OM is able to offer a range of choices that are both situation-appropriate and value-oriented. With a myriad of adjustments, ranges of scale, and abundant design features, OM chairs perform. From the innovative and exclusive “body activated motion” to the more traditional option of multiple independent adjustments, an OM chair responds to your needs for dynamic motion, support, and comfort. Since 1986 OM has been building reliable, high quality, ergonomic seating – and has striven to uphold our reputation as *the source* for smart seating.

## **Local Needs, Global Sourcing**

OM never compromises on quality; whether in its seating, representatives, suppliers, or components. Through successful, long-established global sourcing relationships OM has developed tight-knit vendor-manufacturer partnerships that allow it to incorporate better quality components at a more cost-effective price, thereby creating high value for everyone.

## **Lead Times, Delivery & Distribution**

OM seating is made-to-order and available for shipping from Ontario, California with normal lead-times of around 5 working days. OM's portfolio of end-users includes nationwide-seating standards for many large corporate customers. OM's seating products are available for national distribution and installation through customers' respective servicing dealer networks of choice. OM's authorized dealer distribution strategy affords users the choices they need to source better, more flexible dealer services to meet their specific needs. OM dealers comprise a broad network of supply chain contract furniture dealers, stationary supply chains, medical supply & ergonomic specialty dealers. To find out if a specific dealer is an authorized OM partner, please contact OM toll-free at 877.766.5678.

## **Production Capabilities**

OM routinely leverages its strong supplier relationships and quick turnaround capabilities to customize solutions for specific customer needs. As a committed partner/manufacturer for multiple national accounts, OM has developed a strong reputation for its ability to meet customer requirements with purpose-appropriate and value-oriented seating solutions.

## **Upholstery Options**

OM offers thousands of in-stock and grade-in fabrics, special healthcare-oriented vinyls, cryptons, TB-133, premium leather, and ESD options. We offer a broad range of selections with graded-in pricing from such partners as Designtex, Momentum Textiles, Mayer Fabrics, C.F. Stinson, and more. OM also offers a variety of environmentally-friendly upholstery options from both its in-stock, and graded-in choices. Production lead times on all graded-in upholstery and customer-owned materials may vary based on receipt of material(s).

## **Warranty**

OM chair parts are warranted for lifetime, 12- and 7-year periods (varies by series). Every chair carries a “born-on” production label showing all pertinent information to support follow-up warranty claims. To view a full warranty, please contact OM or turn to page 124 of this price book.

## **Product Selection**

OM offers a broad selection of seating, arms, and other options for a wide array of uses including Ergonomic, Corporate Standards, Medical/Healthcare, Schools, Production, Labs, ESD, Conference, Stacker, Lunchroom, 24-Hour-Use or Call Centers, and Big/Tall. For example, numerous options and styles are available to address all aspects of Healthcare requirements; included are models suited for Nurses' stations, Exam rooms, Doctors' offices, Labs, Counter Height, Administration, Conference, Side chairs, Workstools, Inventory & Executive Ergonomic.

# terms & conditions

These terms and conditions apply to authorized OM dealers.

For additional company or product information, visit us at our online home:  
[omsmartseating.com](http://omsmartseating.com)

**PRICES** Published prices and specifications are approximate and are subject to change without notice. All prices shown in this book are shown at List and F.O.B. OM unless otherwise noted. Prices do not include delivery charges, installations, special handling or any applicable sales, use, excise or other similar taxes. For example, California tax laws require that in cases where an order originates from a dealer outside of CA, but ships to a destination within the state, OM must collect an appropriate sales or use tax. If a customer claims exemption from such taxes, an exemption or CA resale certificate must be furnished to OM upon or before placement of the order.

**TERMS** Terms are net 30 days (on approved credit only) from the date of invoice issuance. A late payment finance charge of 1.5% per month (18% annual percentage rate) will be assessed on all open invoices not paid within terms. Paying within terms will preserve your competitive pricing schedule and payment term.

**CUSTOMER'S OWN MATERIAL C.O.M.** If a customer desires to use a fabric or leather not supplied by OM, it is considered C.O.M. or C.O.L. Refer to the C.O.M. specifications section in this price book (p. 130) for detailed information on the use of such materials. Any C.O.M. and/or C.O.L. rolls, samples, hides, etc. that are being sent to OM for application testing or use on an order should be delivered to:

**OM**  
C/O – C.O.M. and Fabrics Dept  
1110 South Mildred Avenue  
Ontario, CA 91761

A shipping date will not be scheduled until all the C.O.M. materials for an order are received completely by OM. Any request for the return of unused fabrics must be made clearly on the Purchase Order and with specific instructions. Return freight and a handling fee will be charged. Customers should ask their fabric vendors to side-mark all shipping labels for material(s) sent to OM with their company names, fabric colors & patterns, and the purchase order number(s) used with their order at OM.

**CHANGES AND CANCELLATIONS** All changes and cancellations will be subject to approval by OM and must be requested within 24 hours after OM receives the order. Changes and cancellations may only be approved for orders that have not entered any stage of production. A 25% change-order fee will apply to any changed orders. Cancellations, if approved, are subject to a penalty up to the entire amount of the order. Because we make our chairs to order and make every effort to ship as quickly as possible, we strongly discourage making any changes or amendments to your purchase orders whenever possible.

**RETURNS** Returns will not be accepted without an accompanying, written Return Merchandise Authorization Number (RMA). Please contact customer service to obtain an RMA. Returns must be received within 30 calendar days from the date of RMA# issuance. Authorized returned merchandise shall only be delivered to OM on prepaid freight. OM reserves the right to inspect all returned goods before issuing any appropriate credit. A minimum restocking fee of 25% applies to returned merchandise received in good resalable condition. C.O.M. orders may not be eligible for return.

**WARRANTY** The warranty period is listed with each model for the original purchaser only. Full warranty information can be found on the hangtag attached to each chair shipped, as well as on p. 124. OM's sales representatives or customer service will ship appropriate replacement parts when deemed reasonable. Labor, field service or delivery charges are not covered. Unless otherwise specified all OM products are manufactured in accordance with normal commercial usage – for a single 8-hour shift, a total of 40 hours or less per week, and by persons weighing 250 pounds or less. OM shall not be liable for loss or damage resulting from use beyond the approved range or by any cause beyond reasonable control such as abuse, misuse, neglect, alteration, or act of God. Special terms may apply on certain series; please see the relevant product page in this price book for details.

**SHIPPING** (see EZ Freight Program for more information) Most items can be shipped boxed and/or shipped via UPS, except models marked with 'non-UPSable' in this price book. In the absence of specific shipping instructions on purchase orders, OM will select the carrier and the method of shipment based on delivery area, freight cost and quality of service. All freight costs incurred by OM will be charged to the customer except when subsidized under the terms of the EZ Freight Program or other agreement with OM. Please notify the freight company directly in case of any shortage or damages and advise OM immediately of the damages incurred during shipping.

For items shipped in California, please specify the packing preference, whether "Product in Box" or "Assembled" on all purchase orders. There is a minimum charge for blanket-wrap delivery service. Not all areas in California can be shipped assembled or under normal shipping lead times. Please call OM for detailed information.

If you select your own carrier, please clearly state the carrier's name, phone number, your account# with them, the name of a contact person and any special shipping and freight billing instructions on your purchase order to OM.

# limited warranty

---

Office Master, Inc. (OM) warrants to the original purchaser that its products are free from defects in materials and workmanship for the applicable warranty period, as indicated below.

Should any item fail, OM will – at its sole discretion – repair or replace, with a comparable product or part, any item found to be defective as a result of normal commercial use (i.e., a single 8-hour shift, 5 days per week).

This warranty does not apply to items subjected to abuse, misuse, neglect, alteration, or damage caused by shipment, storage, accident, fire, flood, or act of God.

#### **LIFETIME LIMITED WARRANTY**

The OM5 Series® (including the OM5 Active sub-series) is covered by a lifetime limited warranty on all structural components as defined below.

#### **12-YEAR LIMITED WARRANTY**

Unless otherwise specified, all models not classified as budget or 24/7 or heavy-duty are covered under a 12-year limited warranty on all structural components as defined below.

#### **7-YEAR LIMITED WARRANTY**

Unless otherwise specified, all models classified as budget or 24/7 or heavy-duty are covered under a 7-year limited warranty on all structural components as defined below.

#### **WARRANTY TERMS**

Within a given model's applicable warranty period, all structural components, including gas cylinders, wood, metal and plastic parts (i.e., chair frames, bases and control handles) are guaranteed against structural failure when under normal commercial use. All OM seating comes with a default 250 lbs. weight capacity limit unless otherwise specified by OM.

For all models, consumable items (i.e., casters, glides, etc.) are covered by a 5-year normal commercial use warranty.

#### **FABRICS AND FOAM**

OM in-stock upholstery & foam cushions are covered by a 5-year normal commercial use warranty. Normal wear and tear on fabrics such as wrinkling, dirt accumulation or gathering is not covered. Natural, minor variations may exist in color, surface, grain or texture of upholstery materials. As a result, any such variations are not warranted. COM/COL and graded-in fabrics are not covered.

#### **CLAIMS PROCEDURE**

Should any item fail, contact the Dealer from whom it was purchased. If it is determined that a return is necessary, return that item and its product proof of purchase to the Dealer, whereupon that Dealer will send both to OM, freight prepaid. OM will repair or replace the defective part at its sole discretion and return it to the Dealer, freight prepaid.

#### **RETURNS**

Written authorization from OM is required prior to a Dealer returning any failed or defective parts to OM. Any returned defective part(s) will NOT be accepted without this prior written authorization, or a "Returned Materials Authorization" (RMA) # assigned to it.

#### **WARRANTY LABOR**

This warranty exclusively covers the repair or replacement of OM parts and does NOT cover any portion of labor or service.

**GSA-Contract No. GS-28F-0007W**  
**C.A.G.E Code 3HYL1; Fed ID# 33-0151691**  
**Schedule 711-18 & 711-19**  
**Contract Period: 10/24/2014 – 10/23/2019**  
**Authorized Dealer Fee: 10% of Net Purchase Price**  
**\*minority business enterprise and small business**

- 1a. **Special Item Numbers (SIN)** 711-18 Multi-Purpose Seating and 711-19 Guest & Stacking chairs
- 1b. **Lowest Priced Model Number** SIN # 711-18 Multi-Purpose Seating, CL12 Grade 1 \$81.60 and SIN # 711-19 Stackable Seating, SG300 \$64.80
2. **Maximum Order Limitation** \$500,000 Net
3. **Minimum Order Limitation** \$100 Net
4. **Geographic Coverage** 48 Continental United States & Washington D.C.
5. **Point of Production** Ontario, CA 91761
6. **Prices shown herein are Net, discount deducted, Delivered Price. Basic Discount is 52% off June 2015 • 1<sup>st</sup> Edition, Revision 2 Commercial Price List\*\***
7. **Quantity Discounts** N/A
8. **Prompt Payment Terms** Net 30 Days – Authorized Dealer Fee: 10% of Net Purchase Price
- 9a. **Government Credit Card** Visa, Mastercard, AMEX Need Cardholder Name, Card No., Expiration Date, Billing Address, P.O.#, Security Code
- 9b. **Discount for Government Commercial Credit Card** None
10. **Foreign Items** None
- 11a. **Time of Delivery** 2 weeks After Receipt of Order
- 11b. **Expedited Service** Contact Factory (case by case)
- 11c. **Overnight and 2-Day Delivery** Contact Factory
- 11d. **Urgent Requirements** Contact Factory (case by case)
12. **F.O.B. Point** Destination within 48 Contiguous States and Washington D.C.
13. **Ordering Address** OM 1110 South Mildred Avenue Ontario, CA 91761 P: 877-776-5678; 909-392-5678 F: 909-392-4567  
 \*Authorized Dealer should be noted on order
14. **Payment Address** Same As Above
15. **Warranty** Standard Commercial Warranty found on Pg. 124 of price book
16. **Export Packing Charges** Contact Factory
17. **Terms and Conditions of Government Purchase Card Acceptance** See Item # 9
18. **Terms and Conditions of rental, maintenance, and repair** Not Applicable
19. **Terms and Conditions of Installation** Not Applicable
20. **Terms and Conditions of repair parts indicating date of parts price lists and any discounts from list prices** Not Applicable
21. **Servicing Dealers** Not Applicable
22. **List of Participating Dealers** Contact OM
23. **Preventive Maintenance** Not Applicable
24. **Special Attributes** GREENGUARD Gold Certified, Small Business
25. **Data Universal Number System Number (DUNS)** 173255597
26. **Central Contractor Registration** OM is registered with the Central Contractor Registration (CCR) database

\*\* GSA Pricing is based off the **June 2015 • 1<sup>st</sup> Edition, Revision 2** Commercial Price Book at the time of this publication, and until further notice. Please check periodically with OM or an authorized representative for the most current version/generation of our Price Book & Grade-in Lists to ensure correct OM GSA pricing.

The people at OM believe in doing true and everlasting good. We believe that when we promote responsible new practices that build upon the organization's existing good habits, we can not only strengthen our products and the company but just as importantly, meaningfully minimize any negative impact we might have on our surrounding environment.

To this end, we've established at OM a culture of pursuing "Sustainable Environmentalism" —environmentalism that brings into harmony the enterprise's economic and environmental responsibilities.

By making the pursuit of environmental conservation align naturally with the undeniable corporate maxim of economic viability we manage to make OM a more responsible corporate citizen not just for isolated press releases, but day-in and day-out. Now that's taking a meaningful stand and making a positive difference for our future generations.

Here are some of the ways that we at OM are as smart about environmentalism as we are about our seating:

**BUILDING A GREEN HOME** OM has just completed building a new home that meets our twin goals of high efficiency and environmental friendliness. We began by exceeding CA's tough Title 24 energy consumption standards by an average of over 15%, and took it even further by using green building materials throughout...

- High efficiency HVAC units that utilize green refrigerants, zone dampers and energy saving economizers
- LEED-inspired building materials and lighting (CFL bulbs, recycled material in... carpets, corian countertops, office insulation, door cores, etc.)
- Dual-flush, low-flow and sensor-controlled valves on toilets, urinals and sinks
- Daylight, timer- and motion-activated sensor lighting controls in all warehouse, office and production areas
- Green landscaping irrigation systems that utilize reclaimed waste water
- Green-energy equipment (electric-powered forklifts, pallet jacks, and people movers replacing older propane-driven units)

**ENCOURAGING & REINFORCING "GOOD" HABITS** Just as our parents taught us, good habits are important. And good "green" habits are even more important because of the universal impact that they have... we encourage our customers, vendors and employees to all participate in our Sustainable Environmentalism program by cooperating in the following ways:

- Focus on Blanket Wrap shipping programs that utilize no cardboard packaging and maximize the space usage inside a truck because efficiency here means fewer emissions and less truck fuel consumed
- OM receives ongoing recognition for its recycling efforts (winning the California EPA "WRAP" award in 2008, 2009, 2010, 2011, . . .)
- FSC-certified and Recycled content in ALL printed materials – brochures, pricers, business cards, envelopes, labels, etc.
- Minimize cardboard and wood-based packaging materials...
  - > We purchase foam industry scraps to keep them out of landfills a while longer and so that they can be reused to protect our chairs in transit
  - > We purchase collapsible steel cages and instruct our vendors to use them in transporting components to us so that we can save on excess waste associated with cardboard

**BUILDING SUSTAINABILITY INTO OUR PRODUCTS** To OM, sustainability in good product design not only means that our chairs are made to last, but also that our material selections need to be made with the environment in mind. No matter which way you look at it, not having to replace your chair every few years with even the greenest chair not only saves money but also the limited resources of our environment!

- GREENGUARD™ Certification on representative models from major OM product families
- Custom Molded Materials from our CFC-free foam cushions to our plastic components such as shells and casters mean less waste and in many cases better comfort as well.
- Recyclability is a key component of our product sustainability strategy:
  - > Polypropylene is used on many of our components from back shells to arm frames and can be given a second life as everything from washing machine parts to car fenders.
  - > Polyurethane used in creating our seat and back foams can be converted into carpet padding
  - > Aluminum used on our bases footrings can eventually be part of your car, kitchen appliances or even golf clubs and power tools.
  - > Steel is a key structural component used on mechanisms to arm brackets, etc. and it has potential to be re-used in countless ways from buildings to bridges, trucks, tools, etc.
  - > Wood such as that used on our seat and back boards can be shredded into mulch and used for landscaping or allowed to decompose.
- 100% water-based glue from a patented Swiss formula means 0 emissions hazards and an earth-friendly adhesive that works for the chairs and the earth
- Tree-farm harvested seat- and back-woods that are also FSC and CARB-certified give our chairs a sustainable, but durable structural component that lasts
- In-stock and Grade-in fabric selections are a way for our customers to participate in our *Sustainable Environmentalism* effort... OM offers over 40 in-stock options that feature either recycled or recyclable content as well as a very extensive range of green fabrics through our grade-in programs.

Ergonomic features determine which chair will provide the “best fit” for an individual.

The features illustrated here will help you understand the functionality and unique benefits of OM seating.



**BODY-ACTIVATED MOTION**  
Seat & back tilt rate/tension automatically adjusts to occupant weight.

**POSITIVE BACK RELEASE**

Also known as PBR, this safety feature prevents a catapult-launching effect when the tilt lock lever is released. Tilting/rocking features can only be reactivated when body weight is applied on the backrest.



**PNEUMATIC LIFT**  
Adjusts overall height of the chair.



**PIVOT BACKREST**  
Pivots as the user moves.

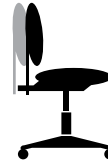

**BACK DEPTH ADJUSTMENT**  
Accommodates a variety of users.

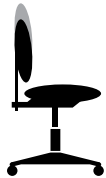

**BACK HEIGHT ADJUSTMENT**  
Allows correct position of lumbar support.



**TILTING BACKREST**  
Locks in an infinite number of positions.



**ADJUSTABLE LUMBAR**  
Provides customized lumbar support.



**SYNCHRONOUS SEAT & BACK TILT**  
Activates single-lever adjustment.



**SLIDING SEAT**  
Adjusts seat depth for a variety of users.



**TILTING SEAT**  
Tilts forward and back for posture.



**TENSION KNOB**  
Controls rate and ease of recline/tilt.



**SWIVEL/ROCKING TILT**  
Provides “rocking motion” in any direction.



**FOOT ACTIVATION RING\***  
Hands-free operation of pneumatic height.

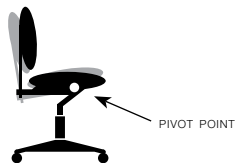

**SIMPLE KNEE TILT**  
Reduce some tension behind knees on tilt.

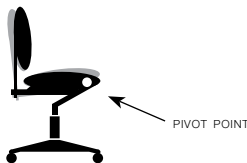

**FULL KNEE TILT**  
Reduce all tension behind knees on tilt.

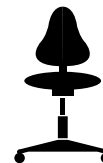

**DISCOVERY BACK DESIGN**  
Prevents scapular impingement.

\* available on CL14 and CL15 only

**ULTIMATE TEST FOR FIT (UTFF)**

## The Work Chair

**(7.1)****SEAT HEIGHT**

Users should be able to sit with their feet comfortably on the floor or footrest without undue pressure on the underside of the thighs. The thigh-to-torso angle should not be less than 90°.

**(7.2)****SEAT DEPTH**

Users should be able to sit in the chair without undue pressure against the back of the knees, their back properly supported by the backrest and with adequate buttock and thigh support.

**(7.3)****SEAT WIDTH**

The seat should be wider than the hip breadth of the user with allowance for movement and clothing. The seat width should not limit the ability to use the armrests comfortably.

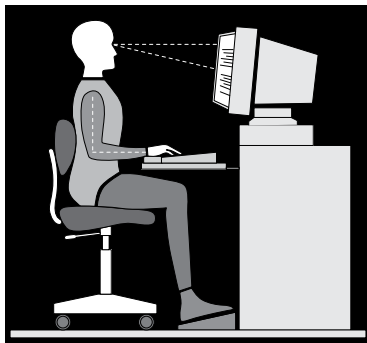
**(7.4)****SEAT PAN ANGLE**

This should allow users to support their feet on the floor or footrest. They should not cause the user's torso-to-thigh angle to be less than 90°. Forward seat pan angles should not cause users to shift excessive weight to their feet or experience the sensation of sliding out of the chair.

**(7.5)****BACK SUPPORT****(7.5.1)****SEAT BACKREST HEIGHT**

All backrests should provide adequate lumbar support and buttocks clearance. For tasks requiring upper body mobility, the backrest should not interfere with the user's movement. For users who prefer reclining postures or greater upper back support, the back height should provide support for the shoulder blades.

**(7.5.2)****BACKREST WIDTH**

The width of the backrest should provide adequate support for the curvature of the user's back without causing localized pressure points.

**(7.5.3)****LUMBAR SUPPORT**

The height and shape of the lumbar support should coincide with the lumbar curve ("the small") of the user's back. The support should be firm, but not cause localized pressure points.

**(7.6)****MOVEMENTS OF THE SEAT PAN AND BACK SUPPORT**

The user should be able to sit in a position where the torso-to-thigh angle is equal to or greater than 90°. The seat and backrest angles should accommodate the varying postures assumed by the user throughout the day.

**(7.7)****ARM SUPPORT****(7.7.1)****ARMREST HEIGHT**

This should allow users to sit in a variety of postures while supporting their forearms and/or elbows in a manner that avoids lifting the shoulders (armrests too high) or leaning to the side to reach the armrest (armrests too low). The armrest height should allow accessibility to, and performance of, tasks.

**(7.7.2)****ARMREST LENGTH**

The length of the armrest should allow users to sit close enough to the work surface to perform their tasks while maintaining contact with the backrest.

**(7.7.3)****INSIDE DISTANCE BETWEEN ARMRESTS**

Armrests should allow users to sit in a variety of postures while supporting their forearms in a manner that avoids lifting the shoulders and/or excessive outward positioning of the elbows. Armrests should allow accessibility to, and performance of, tasks. The inside distance between the armrests should allow the user to enter and exit the chair easily. The hips should comfortably fit between the armrests or supports.



# com, col & grade in fabrics

## features:

Specification form

Guidelines

Designtex

cf Stinson

Mayer fabrics

Momentum textiles

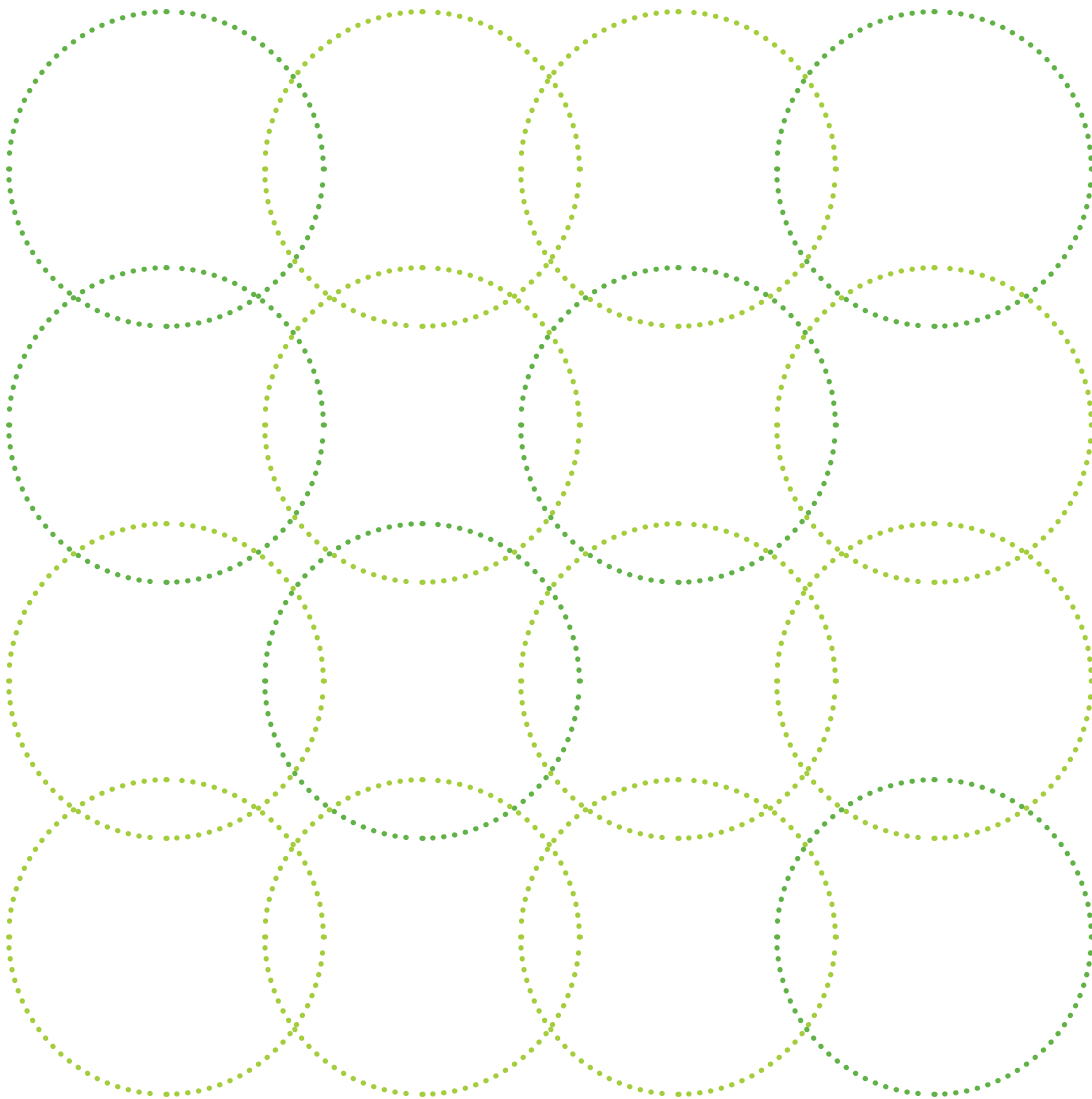

→  
Use our  
handy  
stickers to  
mark this  
section.

COM, COL &  
grade-in fabrics

**WHY READ THIS FORM?** This form describes OM's standard procedures for COM, COL and Grade-In's fabrics and leathers. Reading it will help you understand how your materials will be dealt with, and how to avoid potential misunderstandings and delays with your order.

**WHY FILL OUT THIS FORM?** Fabric designs often come in intricate patterns. Different people may interpret the same fabric's direction in different ways. In order to avoid any confusion and to ensure that your order comes out the way you want, please use this form with your original PO to specify orientation.

**HOW MUCH YARDAGE SHOULD I SEND?** Yardage per chair is estimated in this price list and based upon 54" wide, plain or non-directional material.

Additional yardage may be required if striped or patterned material is used, if pattern requires matching or if width of material is less than 54" wide. Please call us at (877) 776 5678 if you have questions.

**PROCESSING TIME** Orders for production of COM, COL and Grade-In's upholstered products are not scheduled for processing until upholstery material is received. OM will not ship orders until 3-5 business days after receipt of fabric(s) and/or material(s). No CBD or credit hold terms.

**SPLIT ORDERS** If a portion of your shipment does not require COM, please specify whether OM should ship complete or split. By default, OM puts orders on hold until all material is received. Please contact us if you need to split orders.

**CANCELED OR CHANGED ORDERS** Customers are responsible for the cost of the chair and any additional penalties as well as for arranging the return of any extra COM, COL or Grade-In's resulting from changes in upholstery material or cancellation of an order. OM assumes no responsibility for this material.

**EXCESS UPHOLSTERY MATERIAL** OM will dispose of all excess upholstery material unless the customer specifically arranges otherwise.

**UPHOLSTERY MATERIAL DISCREPANCY** OM assumes no responsibility for defects in, or performance of, COM/ COL. But if we detect any flaws with the upholstery material that we receive, we will immediately notify the customer by fax or by phone. In such a case, OM will hold the order until the customer advises us on what to do next. OM is not responsible for any delays on orders in which customer instructions are pending.

Diagram 1: Up the roll, off the roll.



Diagram 2



### COM SPECIFICATIONS FORM

A copy of this form should accompany POs for orders with directional or intricate fabric designs. Please fill out completely.

YOUR NAME AND COMPANY OR ID

PURCHASE ORDER NUMBER

PHONE NUMBER

OM SALES ORDER NUMBER (OPTIONAL)

IF ANY MATERIAL REMAINS AFTER COMPLETION OF MY ORDER, PLEASE...

- Dispose of it for me (default).  
 Return it to me (we will bill the freight).  
 Please see my instructions below.

CHECK THE BOX THAT INDICATES HOW YOUR FABRIC SHOULD RUN

- Selvage top and bottom / railroad       Selvage side and side / top-down



COMPLEX PATTERN (SEE EXPLANATION/INFORMATION BELOW)

Seat

Back

### OM MATERIAL GUIDELINE HIGHLIGHTS

#### COM / GRADE-IN

- Unless otherwise stated, OM will exercise its discretion in choosing fabric direction (usual default as illustrated in Diagram 1, bottom left).\*
- COM must be provided as continuous yardage, and is based upon 54" wide plain or non-directional material.
- Do not fold materials. OM is not responsible for material that is damaged or wrinkled upon receipt.

#### COL

- Leather should be sent in rolls, do not fold. OM is not responsible for material that is damaged or wrinkled upon receipt.
- Outer edges of leather can not be calculated as square feet or yardage.

#### COM & COL

- To avoid delays, all materials sent to OM must include the PO number of your order with us, clearly marked or tagged on all material.
- All fabrics and leathers will be examined before cutting and OM is not responsible for material that is damaged upon receipt.

**COMPLEX PATTERNS** Positioning of intricate patterns or pattern repeats on seat and back default centered (as shown in Diagram 2, bottom left). Customers can use the boxes provided on the COM Specification Form to sketch how they want patterns to appear. Be advised that if your COM or Grade-In's fabric has stripes, you need to state in your PO whether a vertical (up/down) or horizontal (left/right) orientation is to be applied. Otherwise, OM will use its sole discretion. Large pattern repeats may require up to 25% additional yardage.

\* OM's default layout is "Top-Down" (aka, "Off-the-roll"). Guidance from mill's website may be referenced on a case-by-case basis.

**ORDERING GRADE-IN FABRIC**

To order OM seating with a specific, grade-in pattern, you must note the following clearly on your PO:

- 1 Fabric Mill Name (Momentum Textiles, Mayer Fabrics, C.F. Stinson or Designtex)
- 2 Grade-In x (where 'x' is the appropriate grade)
- 3 Your selected "Pattern Name" and "Color Number/Name"
- 4 Layout instructions (see page 130)

If the above information is not clearly and completely noted, OM will assume your PO to be a COM order and will wait for your fabrics to arrive.

**SELECTING PATTERNS**

To choose a pattern, or to see which pricing grade (Grade-In A, B, C, etc.) your selected pattern(s) falls under, please consult the accompanying chart or go directly to the appropriate fabric mill's website. OM's approved patterns are listed under the "Pre-Approval/Grade-ins" section.

Upon selecting a pattern, please note the grade selection noted to the right (see instruction 1 above).

**GRADE-IN SAMPLES**

In order to obtain any samples, please contact the appropriate fabric mill directly via its website or phone number.

Momentum Textiles ([www.themomgroup.com](http://www.themomgroup.com), 800 366 6839)

Mayer Fabrics ([www.mayerfabrics.com](http://www.mayerfabrics.com), 800 428 4415)

CF Stinson ([www.cfstinson.com](http://www.cfstinson.com), 800 841 6279)

Designtex ([www.designtex.com](http://www.designtex.com), 800 221 1540)

**SPLIT ORDERS**

If you would like the items of your order that are not part of the Grade-in program to ship on a separate timeframe than the Grade-in portion of your PO, please contact an OM Customer Service representative to confirm. In such a case, a higher shipping cost for the PO may be incurred.

**LEAD TIMES**

Normal OM lead times for items ordered under the Grade-in program will be measured from the date of the receipt of all fabrics specified for a PO.

Order changes requested 24 hours after the original submission to OM may result in a longer lead time.

Actual processing times are also subject to individual credit terms and assume that all accounts are in good standing.

**WARRANTY**

No OM warranties are implied or given under the Grade-in program beyond the pertinent standard fabric mill's original warranty coverage.

**CHANGE ORDERS AND CANCELLATIONS**

For orders that have entered any stage of the production process, OM can not accept change orders or cancellations.

All fabric order changes (either OM textile or Grade-in) must be received within 24 hours of the original PO submission. Fabric changes to orders after the initial 24 hour period may be assessed additional fees.

### GRADE-IN A

**Fabric**  
Bryant Park

**Vinyl**  
Budget Black

### GRADE-IN B

**Fabric**  
Glacier  
Transcend

**Vinyl**  
All American  
Atlas  
Avant  
Bistro  
Colorguard  
Core  
Laredo  
Moccasin  
Naugasoft  
Neochrome III  
Rally  
Rogue II  
Spirit Millennium  
Whisper

### GRADE-IN C

**Fabric**  
Ace  
Continuum  
Dart  
Furrows  
Hive  
Inside Track  
Lindley Park  
New Hempstead  
Satellite  
Stellar  
Thicket  
Tribeca  
Vision

**Vinyl**  
Atmosphere  
Burkshire  
Carlisle  
Cassidy  
Catalyst  
\* Dakota  
English Pub  
Expressions  
Grand Sierra  
Kilkenny Tweed  
Montana  
Naugaleather  
Oxford

Patriot Plus II  
Rainier  
Rialto  
Scout  
Sentry  
Shantung  
Simplicity  
Smoothie  
Symphony Classic  
Tendrill  
Tessuto  
Vegas  
Ziggy

### GRADE-IN D

**Fabric**  
Arc  
Chauncey  
Crypton Metro  
Modulation  
Nova  
Polka  
Retrograde  
Sideline  
Stipple  
Tracing

**Vinyl**  
Chroma  
Cirque  
Clean Slate  
Dash  
Diva  
Facet  
Finite  
Fizz  
GeoMet  
Liquid  
Matrix  
Mica  
Raffia  
Scribe  
Script  
Sleek  
Sphere  
Stitch in Time  
\* Sundance w/ Stakleen™  
Trax  
Whitney  
\* Wyatt  
Zodiac

### GRADE-IN E

**Fabric**  
Bespoke  
Crypton Suede  
Freehand  
Happy Hour  
Interplay  
Interval  
Line Dance  
Manchester  
Montage  
On The Money  
Persuasion  
Posh  
Realm  
Snuggle  
To the Point  
Tree House  
Velocity

**Vinyl**  
Excursion  
Latitude  
Valise

### GRADE-IN E + \$15

**Fabric**  
Beatbox  
Chloe  
Cozy  
Duet  
Flex  
Haven  
Linus  
Marimba  
Portico

Squire  
Summit  
Vibe  
Zoom

**Vinyl**  
\* Arioso  
\* Modena  
\* Solitaire  
Stat-Con  
Verdure

### GRADE-IN E + \$30

**Fabric**  
Adirondack  
Aero  
Ascend  
Bali  
Bass Line  
Catalina  
Catwalk  
Celeste  
Coco  
Cottonwood  
Equinox  
Florentine  
Hands On  
Hourglass  
Jasmine Screen  
Leaps & Bounds  
Mingle  
Next Scene  
Parapet  
Park Avenue  
Profile  
Raquette  
Spandrel  
Splash  
Straight And Narrow  
Tweed

**Vinyl**  
Abacus  
Bambu-EnVi™  
Bon Voyage  
Casablanca  
Dodgeball  
\* Moxie  
Natural World  
Smile  
Walk the Line

### GRADE-IN E + \$45

**Fabric**  
Balance Beam  
Beep Beep  
Breton  
Colden  
Delphi  
Folio  
Grove  
I Spy  
Jambi Stripe  
Labyrinth  
Lucky Charm  
Mali  
Respite  
Second Act  
Skyline  
Sumatran Palm  
Sunburst  
Tiles Too!

### Vinyl

Affinity  
Aspen  
Banyan  
Bari  
Capreni  
Eli  
Juxy  
Martini  
Olympus  
Prisma  
Rivera  
\* Silverado w/ Agion®  
\* Sterling w/ Agion  
\* Wink w/ Agion  
Ybor

### GRADE-IN E + \$60

**Fabric**  
Acrobat  
Aloha  
Block Party  
Bongo  
Calla  
Cinnamon Blossom  
Comeback  
Courtyard  
Cruisin'  
Curves Ahead  
Detail  
Elderberry  
Firefly  
Flight  
Flip Flops  
Geodesic  
Helix  
Horizons  
Isabella  
Links  
Makeover  
Pacifica  
Panache  
Rolling Stones  
Seagrass  
Sunswept  
Swivel  
Take Two  
Vermont  
View  
Vintage  
Whirl  
Willow Talk

**Vinyl**  
Auberge  
Entrada

### GRADE-IN E + \$75

**Fabric**  
Algiers  
Balustrade  
Canterbury  
Chi w/ Agion®  
Current  
Daddy-O w/ Agion  
Fenestra  
Happy Tappy  
Hudson  
Knock Knock  
Panorama  
San Simeon  
Seville  
Supersilliness  
Voltage

**Vinyl**  
Lava

### GRADE-IN E + \$90

**Fabric**  
Cannon Beach  
Chakra  
Double Time w/ Agion  
Impression  
Jam Session w/ Agion  
Jump w/ Agion  
Kambala  
Ketana  
Lucent  
Now & Zen w/ Agion  
Oscillate  
Radiance  
Scintillate  
Serpentino  
Tessellate  
True Path w/ Agion  
Umbrian Rain  
Up Tempo w/ Agion

**Vinyl**  
Plexus  
Revolve  
Ripple  
Slightwave  
Vortexia  
Waterwand  
Wicker

### GRADE-IN E + \$105

**Fabric**  
Aura  
Deza  
Insignia  
In The Groove w/ Agion  
Malta  
Mumbai  
Salinas  
Spindles  
Tuscan Hills  
Verve w/ Agion

### GRADE-IN E + \$120

**Fabric**  
Acanthus  
Bloom  
Cyma  
Diffusion  
Jala  
Spark  
Stratford  
Varati  
Vineyard  
Wish

### Vinyl

\* Camino  
\* Cielo  
\* E'Lan-HC  
\* Glisten  
\* Mesa  
\* Sedona  
\* Tender  
\* Volterra-HC

### CALL FOR QUOTE

**Leather**  
R.E.I.L.

\* Indicates a PVC free fabric; for content specifications visit C.F. Stinson Fabric's website ([www.cfstinsonfabrics.com](http://www.cfstinsonfabrics.com)).

**GRADE-IN C**

Gamut  
Lofty  
Ludington  
Rocket  
Sandpiper  
Vivid  
Wren

**GRADE-IN D**

Alpine  
Argiano  
Bee  
Boyne  
Crossroads  
Dapper  
Dashing  
Eloquent  
Grandeur  
Great Lakes  
Less Is More  
Linari  
Metta  
Nisa  
Noble  
Nonchalant  
Opulent  
Parga  
Refine  
Singing In The Rain  
Skylark  
Sorano  
Splendor  
Tailored Stripe  
Tarascon  
To The Point  
Versed  
Well Rounded  
Winsome

**GRADE-IN E**

Alchemy  
Anello  
Astrid  
Bolzano  
Botanique  
Breena  
Cascadia  
Catalyst  
Chapiteau  
Chromatic  
Conservation  
Dharma Stripe  
Epiphany  
Glen Arbor  
Kabuki  
Lagoon  
Laque  
Leland  
Lino  
Lioret  
Melange  
Omar  
Pavilion Stripe  
Phase  
Pika  
Pivot  
Prairie  
Reef  
Rivergrass  
Rondine  
Rumeli  
Spandau  
Steppe  
Theory  
Topiary  
Valet  
Zhuba

**GRADE-IN E + \$15**

Agapetos  
Aggregate  
Alcazar  
Allure  
Annex  
Appleseed  
Billiard Cloth  
Bit  
Bolt  
Brooch  
Bunta  
Caillou  
Caiman  
Circolo  
Closed Loop  
Corolle  
Crossover  
Crosswind  
Delaine  
Estuary  
Florin  
Gale  
Gallone  
Griglia  
Hyphen  
Inlet  
Inside Edge  
Introvert  
Kalahari  
Komposition  
Leafette  
Mandala  
Microgrid  
Niello  
Ophidian  
Palomino  
Pianta  
Porte  
Precision  
Restore  
Rivet  
Rivet Pearl  
Round About  
Saugatuck  
Sustain  
Terrasse  
Tombolo  
Travertine  
W

**GRADE-IN E + \$30**

Banda  
Big Dot  
Bottle Bank  
Circa  
Dart  
Drawing Straws  
Figure Eight  
Halos  
Inertia  
Interlock  
Irregular Grid  
Isotope  
Klange  
Laureate  
Leaves  
Lindos  
Little Dot  
Mingle  
Morning Star  
Nexus  
Odeon  
Rice  
Rio Grande  
Rough & Ready II  
Salvage  
Taftan  
Taftan Unfinished  
Transpose  
Vox  
Woodcut  
Yucca

**GRADE-IN E + \$45**

Acacia  
Alemany  
Alistair  
Beguiled By The Wild  
Crosshatch  
Faconne  
Faux Sure  
Friendly Faux  
Fuse  
Gradate  
Kenaf  
Line Item  
Oscillate  
Pinball  
Pop Art  
Pueblo  
Seed  
Sock Hop  
Synthesis  
Terrain  
Tramway  
Tumbleweed  
Tupi  
Wensley  
Yoruba

**GRADE-IN E + \$60**

Amaranth  
Attush  
Barnsbury  
Berber Stripe  
Birch Bark Plaid  
Bordo  
Bossa Nova  
Bounce  
Calm  
Cassava  
Clovis  
Concept  
Converge  
Coupe  
Dahlia  
Dot To Dot  
Drive-In  
Eastside  
Flux  
Hula Hoop  
Jungle Gym  
Landau  
Maglia  
Quintessence  
See Saw  
Sequence  
Soda Pop  
Sonic Plus  
Southside  
Spiro  
Stacks  
Sugar Shoots  
Swing Set  
Tinos  
Token  
Transport  
Urban Grid

**GRADE-IN E + \$75**

Agave  
Alethos Plus  
Alkai  
Amuse  
Baratto  
Bliss  
Block Print  
Bon Bon  
Cestino  
Chandelier  
Chicory  
Cross Court  
Decor  
Gauge  
Guild  
Isometry  
Juxtaposition

Lorien  
Masquerade  
Moderne  
Pen & Ink  
Pigment  
Piiki  
Posey  
Prana  
Razor Stripe  
Reuse  
Rotary  
Rothesay  
Samba  
Samba Otra Vez  
Senna  
Soothe  
Tetris  
Top Spin  
Trocadero  
Valanka  
Volley

Cut & Paste  
Freeze Frame  
Horizon  
Loop To Loop  
Majolica  
Match Point  
Oxford Stripe  
Passage  
Point  
Rosslyn  
Round Leaves  
The Last Aphid

**GRADE-IN E + \$105**

Boreas  
Circumference  
Clyde  
Fortuna  
Henrik Large  
Henrik Small  
Honor Plus  
Inga Large  
Inga Small  
Metamorphosis  
Migration  
New Selkirk  
Perpendicular  
Shimmering Tide  
Tessellate  
Titanium  
Tumble Stones  
Variant  
Wood Work

**GRADE-IN E + \$120**

Abaya  
Aster  
Battista  
Caboose Plus  
Checker Stripe  
Dichotomy  
Henrik Large  
w/ Knit Backing  
Henrik Small  
w/ Knit Backing  
Inga Large  
w/ Knit Backing  
Inga Small  
w/ Knit Backing  
Savile Plaid  
Skye  
Sunburst  
Wire

**GRADE-IN E + \$135**

Array  
Margin  
Modern Tweed

**GRADE-IN E + \$150**

Bainbridge  
Brisbane  
Claire

Culebra  
CUSCO  
Henrietta  
Journey  
Lolland  
Lydia  
Negril  
Robyn  
Rosario  
Santiago  
Terrance  
Tirana  
Valletta

**GRADE-IN E + \$165**

Melrose  
Polygon

**GRADE-IN E + \$180**

Barque  
Kanthas

**GRADE-IN E + \$195**

Gramercy  
M

**GRADE-IN E + \$210**

Mohair Plus  
Mohair Plus III  
Mohair Plus IV  
Paradigm  
Swayed  
Tweed

**GRADE-IN E + \$240**

Chevron  
Cobble  
Trace

**GRADE-IN E + \$255**

Houndstooth Plaid

**GRADE-IN E + \$270**

Basketry

**GRADE-IN E + \$330**

Amwell  
Clerkenwell  
Exmouth  
Myddleton

**GRADE-IN E + \$345**

Genoise



## **GRADE-IN A**

### **Fabric**

Duraweave 10  
Cross Check  
Forte  
Quattro

### **Vinyl**

Special Black - Madrid  
Special Black - Oxen  
Special Black - Sierra  
Special Black - Wallaby

## **GRADE-IN B**

### **Fabric**

Foundation 10  
Amulet  
Artistry  
Banner  
Broadway  
Cavalier  
Dapper  
Figure Eight  
Flourish  
Jubilee  
Mum  
Revival  
Sequel  
Sojourn  
Spacer Mesh  
Sunset Strip  
Tendrill  
Valor

### **Vinyl**

All Seasons  
All Use  
Blocks  
Durango  
\* Emu  
Florentino  
Jamestown  
Key Largo  
\* Kobe  
Linen  
Maverick  
Willow

## **GRADE-IN C**

### **Fabric**

Acanthus  
Axis  
Bijou  
Catalyst  
Component  
Destiny  
Element  
Equation  
Essex  
Factor  
Flower Power  
Focal Point  
Genesis  
Glee  
Haberdash  
Hoopla  
Impulse  
Locomotion  
Madras  
Marquise  
Moonscape  
Mosaic  
Mystic  
Necktie Stripe

Pinnacle  
Rapport  
Ritz  
Sequel (Durablock)  
Shantung  
Sophisticate  
Source  
Venue

### **Vinyl**

Antique  
Athens  
Caressa  
Caressa Suede  
Chaps  
Contempo FR  
Curlicue  
Dakota  
Entwine  
Guardian  
Heather  
Images FR  
Jekyll & Hyde  
\* Komodo  
Micro Dot  
Milano  
Outback  
Peerless  
\* Phoenix  
Pinehurst  
Prado  
Punch  
Sequence  
Silk Screen  
Silverweave  
Sketch  
Toss Up  
Tributary  
Tussah  
Uptown  
Verona

### **Woven Crypton**

Metro

## **GRADE-IN D**

### **Fabric**

Alcazar  
Amulet (Durablock)  
Arcade  
Burst  
Camelot  
Daydream  
Destiny (Durablock)  
Equinox  
Esprit  
Europa  
Genesis (Durablock)  
Glamour  
Hopsack  
In the Groove  
Jenga  
Lunar  
Mirage  
Mosaic (Durablock)  
Mum (Durablock)  
Orbit  
Petit Point  
Plaza  
Portal  
Mosaic (Durablock)  
Mum (Durablock)  
Orbit  
Petit Point  
Plaza  
Portal  
Sojourn (Durablock)  
Source (Durablock)  
Tendrill (Durablock)

Twister  
Ultima  
Valor (Durablock)  
Vibrant  
Vogue

### **Vinyl**

\* Berkshire  
\* Bolero  
\* Cascade  
Charette FR  
\* Counterpoint  
Dande  
Dublin Tweed  
Interlochen  
\* Longhorn  
\* Palermo  
\* Rift  
Slick

### **Woven Crypton**

Acclaim  
Arabesque  
Aristocrat  
Celtic  
Cribbage  
Disco  
Finale  
Habitat  
Holiday  
Jitterbug  
Journey  
Malibu  
Nostalgia  
Pastime  
Pathway  
Primo  
Rain Dance  
Smart Suede  
Social Network  
Stanza  
Suede  
Time Line

## **GRADE-IN E**

### **Fabric**

Abacus  
Array  
Avenue  
Bar None  
Botanica  
Bungalow  
Canvas  
Detail  
Groundworks  
Kismet  
Marvel  
Maze  
Motif  
Myriad  
Nuance  
Paradigm  
Solid Ground

### **Vinyl**

\* Cayman  
\* Cork  
Crystals  
Gala  
\* Glimmer  
\* Hombre  
\* Laredo  
\* Makore  
\* Melody

\* Patent  
\* Shimmer  
Skate  
Spirograph  
Vinyl Stat - ESD  
Webscape

### **Woven Crypton**

Atelier  
Big Top  
Brio  
City Lights  
Debonair  
Domain  
Fable  
Fathom  
Finish Line  
Oxford  
Replay  
Tea Leaves  
Tracery

## **GRADE-IN E + \$15**

### **Fabric**

Bella  
Connections  
Deco Motion  
Ecosphere  
Eleanor Rigby  
Encore  
Facets  
Fantasy  
Hole in One  
Karma  
Luxor  
Nylon-Stat  
Ottoman  
Pulse  
Reiki  
Rhythm  
Rock & Roll  
Soleil  
Spotlight  
Stop & Go  
Turnabout

### **Vinyl**

\* Quark  
\* Ultrahide

### **Woven Crypton**

Amadeus  
Bebop  
Cuddle Up  
Gusto  
On the Spot  
Rebound  
Round 'N Round

## **GRADE-IN E + \$30**

### **Fabric**

Ascension  
Almost Argyle  
Aurora  
Button Down  
Charade  
Circuit  
Circumference  
Cravat  
Erode  
Evolve  
Herringbone  
Illusion

Infinity  
Jumpin' Jacks  
\* Marrakesh  
Matrix  
Oracle  
Pavilion  
Perfectly Paisley  
Play on Plaid  
Relic  
Synapse  
Tangled Web  
Undercurrent  
Wildflower  
Zanzibar

### **Woven Crypton**

Entourage  
Fairy Tales  
Hopscotch  
Nirvana  
Obsession  
Panache  
Paparazzi  
Rialto  
Razzmatazz  
Realm  
Runway  
Solaris  
Whimsy  
Xanadu

## **GRADE-IN E + \$45**

### **Fabric**

Collage  
Enigma  
Natural Progression  
New Angles  
Sakura  
Sashiko

### **Woven Crypton**

Debut  
Escapade  
Frequency  
Frolic  
New Dimensions  
Positive Thoughts  
Swank  
Tangram

## **GRADE-IN E + \$60**

### **Fabric**

Awakening  
Convergence  
Stratosphere

### **Woven Crypton**

Paradise

## **GRADE-IN E + \$75**

### **Fabric**

\* Boteh  
\* Flock  
Empire  
Juncture  
Mandala

## **GRADE-IN E + \$105**

### **Fabric**

Venetian  
Volanté

## **GRADE-IN E + \$135**

### **Fabric**

Vintage Mohair

\* Indicates a PVC free fabric; for content specifications visit Mayer Fabric's website ([www.mayerfabrics.com](http://www.mayerfabrics.com)).





**GRADE-IN A**

Bangle  
Impact  
Interval  
Knack

**GRADE-IN B**

Ace  
Axis  
Basis  
Cinch  
Context  
Core  
Epic  
Expo  
Fuse  
Gauge  
Infinity  
Insight  
Jargon  
Lineup  
Marathon  
Millennium  
Moda  
Odyssey  
Origin  
Perk  
Ratio  
Sector  
Tangent  
Tate  
Tradition  
Vox

**GRADE-IN C**

☼ Beeline  
☼ Canter  
Current  
Decode  
☼ Eon  
Focal  
Free  
Gusto  
Habit  
Hue  
Intersect  
Propensity  
Skip  
Stance  
Streamers  
Syntax  
Via

**GRADE-IN D**

Abaca  
☼ Agora  
Amble  
Amuse  
Avenue  
Boom  
☼ Bravo  
Candid  
☼ Cashmere  
☼ Cashmere II  
Clang  
Fino  
Intermix  
Intermix II

Kinney  
Luz  
Maslin  
Pace Incase  
Quirk  
Realm

☼ Rein  
☼ Rein II  
☼ Row  
Savant  
Solace  
Solo  
Solo 2  
☼ Sublime  
☼ Sublime II  
☼ Tetra  
Vario  
☼ Velocity  
Venue

**Crypton**  
Cover Cloth  
Keynote

**GRADE-IN E**

☼ Bravo II  
☼ Echo  
☼ Foray  
☼ Max  
Medley  
Parkside Incase  
Picaro  
Prospect  
Sense  
Sidebar Incase  
☼ Tact  
Tone  
Vivo

**Crypton**  
Isla  
Pace Crypton  
Redux  
Scribe  
Span Crypton  
Synergy

**GRADE-IN E + \$15**

Abuzz  
April  
Beep  
Delve  
Dive  
Element  
Essentia  
Gesture  
☼ Icon  
Kindle  
Matter  
☼ Paragon  
☼ Silica  
Veer  
X-Factor

**Crypton**  
Crux  
Oath  
Viva

**GRADE-IN E + \$30**

Acacia  
Amenity  
Bandwidth  
Crew  
Dash  
Duo  
Jitney  
☼ Kindred  
Whim  
☼ Silica Leather  
☼ Silica Tech

**Crypton**  
Huntington  
Infusion  
Jest  
Sidebar Crypton  
Sway  
Upside

**GRADE-IN E + \$45**

Allegory  
Audio  
Bento  
Bias  
Brisk  
Camber  
Centric  
Cite  
Dayspell  
Drift  
Edison  
Idiom  
Jardin  
Scape  
Small Talk  
Sort  
Tesla  
Wander  
Weaving Palettes

**Crypton**  
Ardour  
Evolve  
Feliz  
Mantra  
Mojo  
Narration  
Recollection  
Soma  
Spin  
Strada  
Telegram

**GRADE-IN E + \$60**

Arrange  
Banter  
Bloc  
Boxcar  
☼ Carouse  
Cienega  
Course  
Dividend  
Estrella  
Flux  
Hearsay

☼ Identity  
☼ Imprint  
Index  
Inner Circle  
☼ Innuendo  
Interim  
Kudos  
☼ Masque  
Melodeon  
Neon  
Panorama  
☼ Periphery  
Photon  
Proximity  
Rally  
Riga  
Tactic  
Trove  
Turin  
Twist

**Crypton**  
Align  
Catalogue  
Elevate  
Flection  
Heyday  
Hula  
Idyll  
Mensa

**GRADE-IN E + \$75**

Audubon  
Bestow  
Cairns  
Chipper  
Crossing Colors  
Drawing Lines  
Juncture  
Malmo  
Mix  
Molto  
Nagoya  
Nimble  
Painting Strokes  
Revolve  
Scan  
Symbol

**Crypton**  
Charade  
Effloresce  
Emanate  
Inhabit  
Torque

**GRADE-IN E + \$90**

Geo  
Livia  
Ohs  
☼ Silica Etch

**Crypton**  
Intermezzo

☼ Indicates a coated fabric. For detailed specifications visit Momentum Group's website ([www.themomgroup.com](http://www.themomgroup.com)).

Fabrics listed above were current at the time of printing. For an up-to-date list, please visit the Fabrics/Grade-In's section of OM's website ([omsmartseating.com](http://omsmartseating.com)). OM's graded-in pattern and color selections are subject to change without notification.







# optional arm kits, arm tops & arm pads

features:

Arm rests

Arm pads

Arm tops

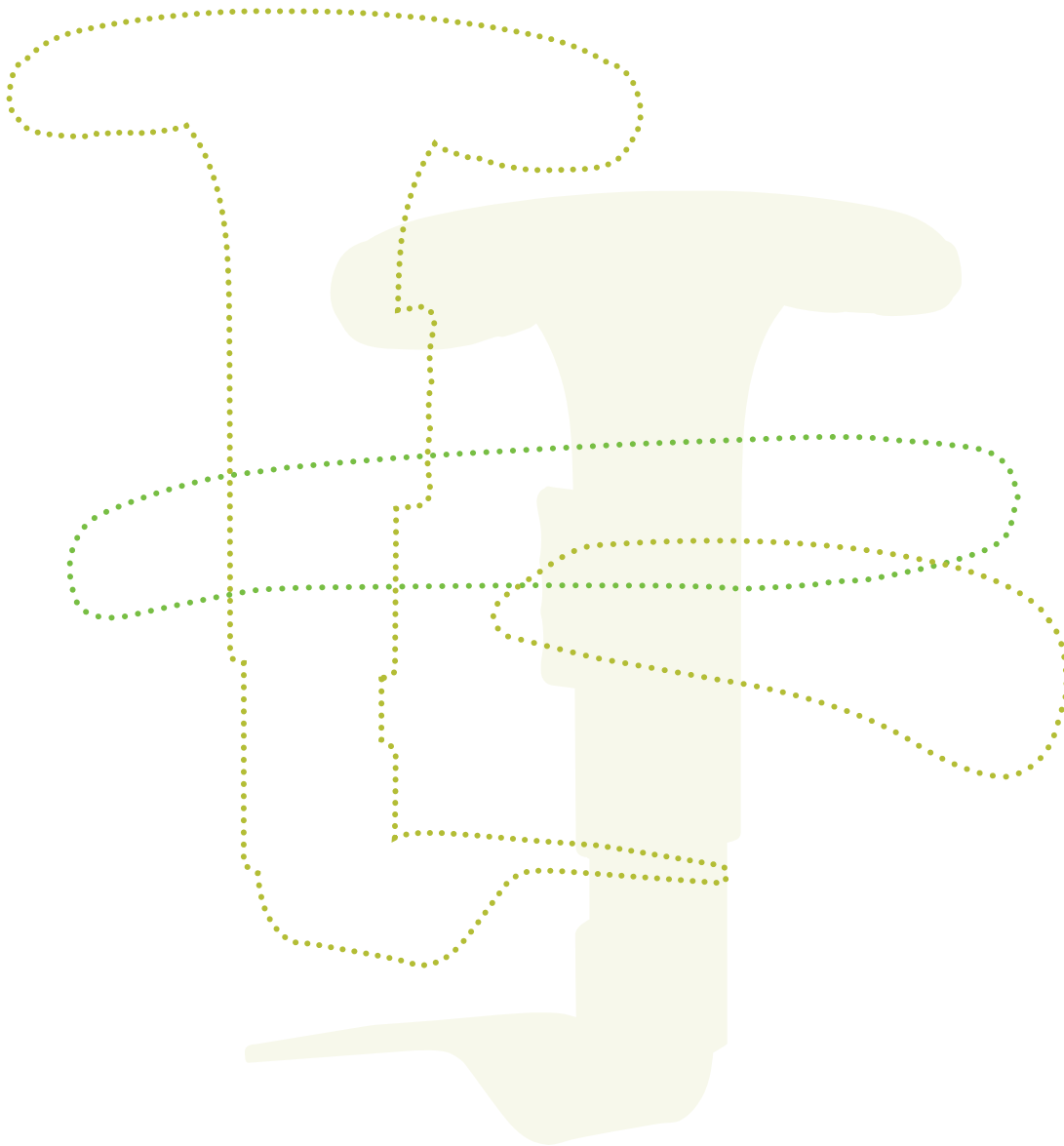

→  
Use our  
handy  
stickers to  
mark this  
section.

optional arm  
kits, arm tops &  
arm pads

# arm matrix

## "WELL-ARMED" (FOR GOOD ERGONOMICS)





35+ everyday arms, 5 different arm tops (i.e., pads with motion), myriad additional custom combinations... I guess you could say we believe in offering choices to our customers!

Choosing arms to fit your working style is important. Yet, when it comes to arm selection, we have found that opinions vary widely. Some would say that good arms get out of your way during work, and then are available as occasional rests for when you need a break from the action.

Others believe that arms are meant to offer continuous support even while working... witness the KR-251M track arms which are "move with you as you work" specialty arms that we developed for Google employees to use in a book-scanning project.



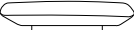

No matter your personal philosophy on arms, we've got enough choices to satisfy even the Goldilocks amongst you with something that is "just right".

Use this matrix as a starting point for just some of our more popular arm models; a reference to explain some of the more common model numbers you'd order, depending on which arm function/style you are seeking...

| Arm Frame Description                      | Regular Arm | ARM PAD  | ARM TOPS   |   |  |  |
|--|-------------|--|--|---|--|--|
|  |             | Memosoft Pads (-MRM)   | 2-way Motion (-RPXM)   | 5-way Adjustable (-RP45)  | 6-way Adjustable (-RP50)   | 6-way Adjustable & Lockable (-RP65)  |
|  |             |  |  |  |  |  |
| <b>T-ARMS</b>                              |             |  |  |   |  |  |
| Low (2.75" range) Starting height          | N/A         | KR240M   | KR240-XM   | KR445   | KR540  | KR465  |
| Average (2.75" range) Starting height      | KR200       | KR200M   | KR200-XM   | KR200-45  | KR500  | KR200-65   |
| Tall (2.75" range) Starting height         | KR300       | KR300M   | KR300-XM   | KR300-45  | KR600  | KR300-65   |
| Tall (4.25" range) Starting height         | JR77        | JR77M  | JR77-XM  | JR77-45   | JR77-50  | JR77-65  |
| <b>FORWARD SLANTING</b>                    |             |  |  |   |  |  |
| Tall (4.25" range) Average starting height | JR39        | JR39M  | JR39-XM  | JR49  | JR59   | JR69   |
| OM5 Arm Codes                              | MR5 / 'A'   | MRM  | MRXM   | MR45  | MR50   | MR65   |

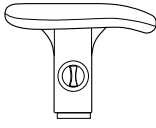
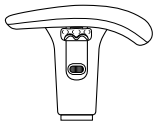
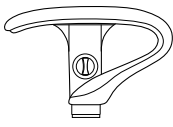
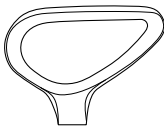
For pricing and more specifics about these (and even more) arm choices, please reference the following pages.

For experienced guidance and/or suggestions, please contact your favorite OM representative or the factory directly – toll free **877 776 5678**

| Model  | Group                             | List  | Description  |
|--|-----------------------------------|---|--|
| <b>KR-21</b><br>            | Group 1                           | <b>\$65.00</b><br>(KR-21)                                   | Contoured height adjustable T-arms<br>Adjustable height range of 2.25"<br>12 year limited warranty on arm frames & 2 year limited warranty on arm pads*  |
| <b>KR-25/KR25M</b><br>      | Group 1<br>With Memosoft arm pads | <b>\$79.00</b><br>(KR-25)<br><b>\$111.00</b><br>(KR-25M)    | Contoured height adjustable T-arms featuring natural grip control<br>Adjustable height range of 2.75"<br>12 year limited warranty on arm frames & 2 year limited warranty on arm pads*   |
| <b>KR-32</b><br>            | Group 1                           | <b>\$87.00</b>  | Height adjustable open loop arms<br>Adjustable height range of 2.25"<br>12 year limited warranty on arm frames & 2 year limited warranty on arm pads*  |
| <b>KR48</b><br>            | Group 1                           | <b>\$99.00</b>  | Fixed loop arms<br>7 year limited warranty*  |
| <b>KR-200/KR-200M</b><br> | Group 1<br>With Memosoft arm pads | <b>\$109.00</b><br>(KR-200)<br><b>\$141.00</b><br>(KR-200M) | Height and width adjustable and removable T-arms with natural grip control<br>Adjustable height range of 2.75"<br>Adjustable width range of approximately 1.25" per side<br>12 year limited warranty on arm frames & 2 year limited warranty on arm pads*        |
| <b>KR-200-45</b><br>      | Group 1                           | <b>\$224.00</b>   | 2-way adjustable width/height and removable T-arms with RP45 arm pads<br>Adjustable height range of 2.75"<br>Adjustable width range of approximately 1.25" per side<br>12 year limited warranty on arm frames & 2 year limited warranty on arm pads*             |
| <b>KR-200-65</b><br>      | Group 1                           | <b>\$244.00</b>   | 2-way adjustable width/height and removable T-arms with RP65 lockable arm pads<br>Adjustable height range of 2.75"<br>Adjustable width range of approximately 1.25" per side<br>12 year limited warranty on arm frames & 2 year limited warranty on arm pads*    |
| <b>KR-240M</b><br>        | Group 1<br>With Memosoft arm pads | <b>\$134.00</b>   | Lowest height and width adjustable and removable T-arms with natural grip control<br>Adjustable height range of 2.75"<br>Adjustable width range of approximately 1.25" per side<br>12 year limited warranty on arm frames & 2 year limited warranty on arm pads* |

NOTES FOR PAGE 139:







Overall width of chair will be increased 5" with Group 1 arms.  
Overall weight of chair will be increased by approximately 8-12 pounds.

\*Warranty on arms does not cover conditions beyond standard commercial use.

Arm kits contain left and right side arms, prices above are per set. ; See page 124 for OM warranty information. ; Pricing and specifications subject to change without notification.

# optional arm kits

group 1, series KR

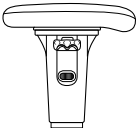
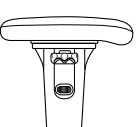
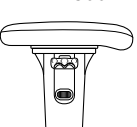
| Model  | Group                                 | List  | Description  |
|--|---------------------------------------|---|--|
| <b>KR-251M</b><br>        | Group 1<br><br>With Memosoft arm pads | <b>\$185.00</b>   | Ultra-mobility arms with extension, 3-stage swivel and unlimited inside pivoting on the lowest height and width adjustable and removable T-arms<br>Overall height travel: 6.9-9.5" from seat cushion (varies) 2" width travel/side<br>12 year limited warranty on arm frames & 2 year on arm pads* |
| <b>KR-300/KR-300M</b><br> | Group 1<br><br>With Memosoft arm pads | <b>\$134.00</b><br>(KR-300)<br><br><b>\$166.00</b><br>(KR-300M) | Tallest height, width-adjustable T-arms with waterfall front and contoured armpads.<br>12 year limited warranty on arm frames & 2 year on arm pads*  |
| <b>KR-300-45</b><br>      | Group 1                               | <b>\$249.00</b>   | Tallest height, width-adjustable T-arms with RP45 arm pads<br>Adjustable height range of 2.75"<br>Adjustable width range of approximately 1.25" per side<br>12 year limited warranty on arm frames & 2 year on arm pads*   |
| <b>KR-300-65</b><br>     | Group 1                               | <b>\$269.00</b>   | Tallest height, width-adjustable T-arms with RP65 lockable arm pads<br>Adjustable height range of 2.75"<br>Adjustable width range of approximately 1.25" per side<br>12 year limited warranty on arm frames & 2 year on arm pads*  |
| <b>KR-445</b><br>       | Group 1                               | <b>\$175.00</b>   | Height and width adjustable T-arms with smooth fore-aft, side-to-side, and pivoting motion arm caps<br>Adjustable width range of approximately 1.25" per side<br>12 year limited warranty on arm frames & 2 year limited warranty on arm pads*   |
| <b>KR-465</b><br>       | Group 1                               | <b>\$195.00</b>   | Height and width adjustable T-arms with lockable fore-aft, side-to-side, and pivoting motion arm caps<br>Adjustable width range of approximately 1.25" per side<br>12 year limited warranty on arm frames & 2 year on arm pads*  |
| <b>KR-500</b><br>       | Group 1                               | <b>\$219.00</b>   | Ergonomic maximum-mobility arms with full range of motion including sliding and pivoting<br>12 year limited warranty on arm frames & 2 year on arm pads*   |
| <b>KR-540</b><br>       | Group 1                               | <b>\$219.00</b>   | Lower starting-height version of KR-500 (based on KR-240 arm frame)<br>12 year limited warranty on arm frames & 2 year on arm pads*  |
| <b>KR-600</b><br>       | Group 1                               | <b>\$259.00</b>   | Taller starting-height version of KR-500 (based on KR-300 arm frame)<br>12 year limited warranty on arm frames & 2 year on arm pads*   |

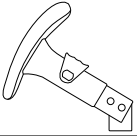
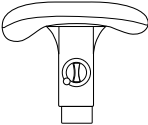
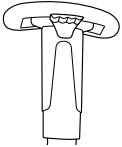
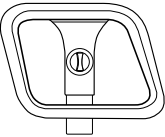
| Model   | Group                                 | List   | Description   |
|---|---------------------------------------|--|---|
| <b>ETR1</b><br>          | Group 1                               | <b>\$40.00</b>   | Fixed loop arms<br>7 year limited warranty*   |
| <b>JR-BN/JR-PD</b><br>   | Group 1                               | <b>\$257.00</b><br>(JR-BN)<br><b>\$257.00</b><br>(JR-PD) | Height adjustable T-arms with fold back feature and trigger-style control<br>Adjustable height range of 2.5"<br>Ballistic nylon upholstered arm pads (on JR-BN)<br>Memosoft arm pads (on JR-PD)<br>7 year limited warranty on arm frames & 2 year limited warranty on arm pads* |
| <b>JR-75</b><br>         | Group 1                               | <b>\$127.00</b>  | Height adjustable T-arms with fabric arm pads<br>Adjustable height range of 2.25"<br>COM .33 yard<br>12 year limited warranty on arm frames & 2 year limited warranty on arm pads*  |
| <b>JR-77/JR-77M</b><br> | Group 1<br><br>With Memosoft arm pads | <b>\$95.00</b><br>(JR-77)<br><b>\$127.00</b><br>(JR-77M) | Height adjustable T-arms with molded arm pads<br>Adjustable height range of 4.25"<br>12 year limited warranty on arm frames & 2 year limited warranty on arm pads*  |
| <b>JR-90</b><br>       | Group 1                               | <b>\$147.00</b>  | Height adjustable loop arms<br>Adjustable height range of 2.5"<br>12 year limited warranty on arm frames*   |

**NOTES FOR PAGE 140 AND 141:**





Overall width of chair will be increased 5" with Group 1 arms.  
Overall weight of chair will be increased by approximately 8-12 pounds.

\*Warranty on arms does not cover conditions beyond standard commercial use.

Arm kits contain left and right side arms, prices above are per set. ; See page 124 for OM warranty information. ; Pricing and specifications subject to change without notification.

# optional arm kits

group 4, series JR

| Model   | Group                                    | List  | Description   |
|---|--|---|---|
| <b>JR-39/JR39M</b><br> | Group 4<br><br>With Memosoft<br>arm pads | <b>\$122.00</b><br>(JR-39)<br><br><b>\$154.00</b><br>(JR-39M)<br><br><i>Does not retrofit</i> | 2-way adjustable width/height and removable<br>Forward-slanting T-arms with soft arm pads and natural<br>grip control<br>Black only<br>Adjustable height range of 4.25"<br>Adjustable width range of 1.75" each side<br>7 year limited warranty on arm frames & 2 year on arm pads* |
| <b>JR-49</b><br>       | Group 4                                  | <b>\$186.00</b><br><br><i>Does not retrofit</i>   | 2-way adjustable (W/H) forward-slanting T-arms with RP45<br>arm pads<br>Black only<br>Adjustable height range of 4.25"<br>Adjustable width range of 1.75"<br>7 year limited warranty on arm frames & 2 year on arm pads*  |
| <b>JR-59</b><br>       | Group 4                                  | <b>\$195.00</b><br><br><i>Does not retrofit</i>   | 2-way adjustable (W/H) forward-slanting T-arms with RP50 mobility<br>arm pads<br>Black only<br>Adjustable height range of 4.25"<br>Adjustable width range of 1.75"<br>7 year limited warranty on arm frames & 2 year on arm pads*   |
| <b>JR-69</b><br>      | Group 4                                  | <b>\$206.00</b><br><br><i>Does not retrofit</i>   | 2-way adjustable (W/H) forward-slanting T-arms with RP65<br>lockable arm tops<br>Black only<br>Adjustable height range of 4.25"<br>Adjustable width range of 1.75"<br>7 year limited warranty on arm frames & 2 year on arm pads*   |





**NOTES:**

Overall width of chair will be approximately increased 5" with Group 1 arms.  
 Overall weight of chair will be increased by approximately 8-12 pounds.

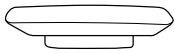

\*Warranty on arms does not cover conditions beyond standard commercial use.

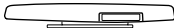
Arm kits contain left and right side arms, prices above are per set. See page 124 for OM warranty information. Pricing and specifications subject to change without notification.

# optional arm tops & arm pads

| Arm Tops  | Group                  | List   | Description  |
|---|------------------------|--|--|
| <b>RP-45</b><br> | Arm Top<br>Group 1 & 4 | <b>\$115.00*</b><br>per set<br><br><i>Representative image - actual arm top may vary</i> | Multi-position arm top with smooth fore-aft, side-to-side, and pivoting motion arm caps                      |
| <b>RP-50</b><br> | Arm Top<br>Group 1 & 4 | <b>\$125.00*</b><br>per set<br><br><i>Representative image - actual arm top may vary</i> | 5-way, ultra-adjustable arm top (retrofits to most Group 1 and Group 4 arms)<br>2 year limited warranty*     |
| <b>RP-65</b><br> | Arm Top<br>Group 1 & 4 | <b>\$135.00*</b><br>per set<br><br><i>Representative image - actual arm top may vary</i> | 6-way adjustable & lockable arm top (retrofits to most Group 1 and Group 4 arms)<br>2 year limited warranty* |
| <b>RP-XM</b><br> | Arm Top<br>Group 1 & 4 | <b>\$135.00</b><br>per set<br><br><i>Representative image - actual arm top may vary</i>  | 2-way adjustable arm top (retrofits to most Group 1 and Group 4 arms)<br>2 year limited warranty*            |

\* List price when ordered on OM5®

| Arm Pads   | Group   | List   | Description  |
|--|---|--|--|
| <b>Type 1</b><br> | Arm Pad<br>Group 1 & 4<br><br><i>Arm pad codes will vary. See description at right for details.</i> | <b>\$28.00</b><br>per set<br><br><i>Representative image - actual arm pad may vary</i> | Arm pads for the following arms:<br>BR-5, JR-39, JR-77, KR-21, KR-25, and KR-200   |
| <b>Type 2</b><br> | Group 1<br><br><i>Arm pad codes will vary. See description at right for details.</i>                | <b>\$39.00</b><br>per set<br><br><i>Representative image - actual arm pad may vary</i> | Arm pads for the following arms:<br>JR-30M (Memosoft), JR-40M (Memosoft), JR-75, JR-90, KR-25M (Memosoft), KR-32, KR-251M (Memosoft), and KR-200M (Memosoft) |
| <b>Type 3</b><br> | Group 1<br><br><i>Arm pad codes will vary. See description at right for details.</i>                | <b>\$69.00</b><br>per set<br><br><i>Representative image - actual arm pad may vary</i> | Arm pads for JR-BN arms  |

### WHEN ORDERING ARM PADS

Order arm pads by specific arm model numbers found under DESCRIPTION. OM can NOT fulfill arm pad orders that use Type only when ordering.

#### NOTES:

Overall width of chair will be approximately increased 5" with Group 1 arms.  
Overall weight of chair will be increased by approximately 8-12 pounds.

\*Warranty on arms does not cover conditions beyond standard commercial use.

Arm kits contain left and right side arms, prices above are per set. ; See page 124 for OM warranty information. ; Pricing and specifications subject to change without notification.





# optional casters & cylinders

## features:

Casters for all types of flooring

Cylinders for achieving various seat heights



→  
Use our  
handy  
stickers to  
mark this  
section.

optional casters  
& cylinders

# casters

## guidelines and selection

|                   | List \$ (Upcharge) | List \$ (Buy)  | Description   |
|-------------------|--------------------|----------------|---|
| <b>CAS-REG</b>    | <b>N/A</b>         | <b>\$30.00</b> | <b>Regular Caster</b><br>Designed for use on carpet (5 per set, standard on most chairs)                  |
| <b>GLD-R</b>      | <b>N/A</b>         | <b>\$30.00</b> | <b>Glide</b><br>Keeps the chair stationary at all times (5 per set)                                       |
| <b>CAS0050-SS</b> | <b>\$25.00</b>     | <b>\$45.00</b> | <b>Safety Soft Caster</b><br>Minimizes chair movement when NOT in use (5 per set)                         |
| <b>CAS0050-RB</b> | <b>\$35.00</b>     | <b>\$55.00</b> | <b>Reverse Braking Caster</b><br>Restricted chair movement when chair IS in use (5 per set)               |
| <b>CAS0065-S</b>  | <b>\$25.00</b>     | <b>\$45.00</b> | <b>Multi-Surface Soft Caster</b><br>Dual-colored; designed for wood, tile and smooth surfaces (5 per set) |
| <b>CAS-RUB</b>    | <b>\$25.00</b>     | <b>\$45.00</b> | <b>Rubber Caster</b><br>Designed for concrete and other hard surfaces (5 per set)                         |



**GLD-R**  
Glider

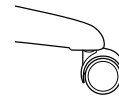

**CAS0050-SS**  
Self Braking Safety

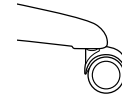

**CAS0050-RB**  
Reverse Braking

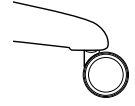

**CAS0065-S**  
Soft Caster

OM provides you with a range of caster options to accommodate your working environment. Tailor your caster selection specifically to the type of flooring where your seating will be used. Refer to the chart below to help you choose the caster that is right for you.

|                                 | SOFTEST SURFACE   |                   |                   | HARDEST SURFACE   |                   |                   |
|---------------------------------|-------------------|-------------------|-------------------|-------------------|-------------------|-------------------|
|                                 | Carpet            | Chair Mat         | Wood              | Tile              | Linoleum          | Concrete          |
| <b>Regular Caster</b>           | <b>Excellent!</b> | Fair              | Poor              | Poor              | Poor              | Poor              |
| <b>Glide</b>                    | Fair              | Fair              | Fair              | Fair              | Fair              | Fair              |
| <b>Safety Soft Caster</b>       | Poor              | <b>Excellent!</b> | <b>Excellent!</b> | <b>Excellent!</b> | <b>Excellent!</b> | <b>Excellent!</b> |
| <b>Reverse Braking Caster</b>   | Poor              | Fair              | Fair              | Fair              | Fair              | Fair              |
| <b>Soft Caster ("Duo-soft")</b> | <b>Excellent!</b> | <b>Excellent!</b> | <b>Excellent!</b> | <b>Excellent!</b> | <b>Excellent!</b> | <b>Excellent!</b> |
| <b>Rubber Caster</b>            | Fair              | Fair              | Fair              | Fair              | <b>Excellent!</b> | <b>Excellent!</b> |

Similar to the way tires on a car eventually wear out, even the most well-made casters are subject to wear and tear. While performing routine maintenance will extend the life of your casters, eventually you may need to replace them.

|                  | List \$ (Upcharge) | List \$ (Buy)  | Description   |
|------------------|--------------------|----------------|---|
| <b>CYL-5</b>     | <b>\$20.00</b>     | <b>\$70.00</b> | 5" cylinder for most task and executive chairs (also available in chrome, call for price) |
| <b>CYL-5CR</b>   | <b>\$20.00</b>     | <b>\$85.00</b> | 5" cylinder for most task and executive chairs. Chrome housing with black colored piston  |
| <b>CYL-8CHD</b>  | <b>\$30.00</b>     | <b>\$95.00</b> | 8" cylinder to accommodate intermediate drafting desk                                     |
| <b>CYL-10CHD</b> | <b>\$30.00</b>     | <b>\$95.00</b> | 10" cylinder in chrome for drafting stools  |

*Available on chairs that are not BC or WS (except WS15 & WS15VS) Series.*

Cylinders below are heavy-duty versions available on certain OM models (check with factory for model compatibility)

|                 |                |                 |   |
|-----------------|----------------|-----------------|---|
| <b>CYL-4HD</b>  | <b>\$30.00</b> | <b>\$95.00</b>  | 4" heavy-duty cylinder (check with factory for model compatibility) |
| <b>CYL-5HD</b>  | <b>\$30.00</b> | <b>\$95.00</b>  | 5" heavy-duty cylinder (check with factory for model compatibility) |
| <b>CYL-6SHD</b> | <b>\$40.00</b> | <b>\$100.00</b> | 6" heavy-duty cylinder (check with factory for model compatibility) |

Choosing the appropriate cylinder for both your working environment and working style is critical to proper ergonomics and your long-term seating comfort.

Cylinders (aka Gas Lifts or Pneumatic Cylinders) are a paradox. While they are one of the easiest — and most important — parts of your chair to adjust, they can also be one of the hardest parts of your chair to understand. Thankfully there is only one main area that you really need to consider when specifying for that perfect fit: Travel Range.

Travel range is usually expressed in approximate inches and is the total distance that the telescoping portion of the assembly can travel. A 5 inch cylinder has approximately 5 inches of travel from full compression to full extension, a 7 inch cylinder has approximately 7 inches of travel, respectively.

When considering the Travel Range for your seating needs, it is important to bear in mind that your working environment and style together determine what's appropriate for you. See the chart below for more details.

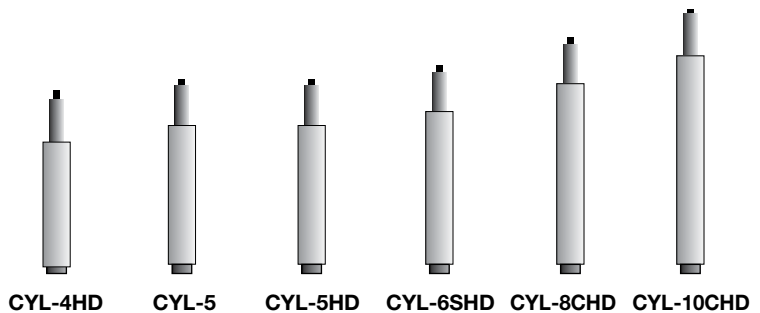

| Category  | Desk Height          |          |          |        | Counter Height |        |
|---|----------------------|----------|----------|--------|----------------|--------|
|   | <b>Actual Travel</b> | 88 mm    | 121 mm   | 121 mm | 162 mm         | 202 mm |
| <b>Comparative Max. Height*</b><br>(As measured from cyl-5 as a "standard") | -2.5"                | standard | standard | +4"    | +7.3"          | +13.5" |
| <b>Comparative Min. Height*</b><br>(As measured from cyl-5 as a "standard") | -1.3"                | standard | standard | +2.5"  | +4.3"          | +8.2"  |

\* All measurements are approximate and are based on switching cylinder heights on otherwise the same chair, with the same base and casters.

BIFMA UTFF (Ultimate Test For Fit) for the work chair states that users should be able to sit with their feet comfortably on the floor or footrest without undue pressure on the underside of the thighs. The thigh-to-torso angle should not be less than 90°.



|   |   |   |
|---|---|---|
| <p>affirm series (AF)</p> <p>affirm series (AF)</p>   | <p>OM5 series®</p> <p>OM5 series®</p>   | <p>classic specialty stools (CL)</p> <p>classic specialty stools (CL)</p>                           |
| <p>bc series</p> <p>bc series</p>   | <p>pacific series (9xxx)</p> <p>pacific series (9xxx)</p>   | <p>stackable guest series (SG)</p> <p>stackable guest series (SG)</p>                               |
| <p>conference executive series (CE)</p> <p>conference executive series (CE)</p>               | <p>paramount (PT / 7xxx)</p> <p>paramount (PT / 7xxx)</p>   | <p>stacking chair series (ST)</p> <p>stacking chair series (ST)</p>                                 |
| <p>classic professional series (CL)</p> <p>classic professional series (CL)</p>               | <p>patriot series (PA &amp; PC)</p> <p>patriot series (PA &amp; PC)</p>                               | <p>worktools (WS)</p> <p>worktools (WS)</p>   |
| <p>classic lab stools (CLS)</p> <p>classic lab stools (CLS)</p>                               | <p>yes series (YS)</p> <p>yes series (YS)</p>   | <p>OM company information</p> <p>OM company information</p>   |
| <p>discovery back series (DB)</p> <p>discovery back series (DB)</p>                           | <p>zesta series (ZA)</p> <p>zesta series (ZA)</p>   | <p>COM, COL &amp; grade-in fabrics</p> <p>COM, COL &amp; grade-in fabrics</p>                       |
| <p>intensive use 24-seven (IU)</p> <p>intensive use 24-seven (IU)</p>                         | <p>guest, stackable &amp; specialty seating</p> <p>guest, stackable &amp; specialty seating</p>       | <p>optional arm kits, arm tops &amp; arm pads</p> <p>optional arm kits, arm tops &amp; arm pads</p> |
| <p>maxwell intensive use (MXIU &amp; MXPD)</p> <p>maxwell intensive use (MXIU &amp; MXPD)</p> | <p>OM5 active tasker, stacker &amp; cafe stool</p> <p>OM5 active tasker, stacker &amp; cafe stool</p> | <p>optional casters &amp; cylinders</p> <p>optional casters &amp; cylinders</p>                     |

Use these handy stickers to mark the sections in this price book.

| UPHOLSTERY*             | List \$ (Upcharge) | List \$ (Buy)   | Description   |
|-------------------------|--------------------|-----------------|---|
| <b>DCS™ Technology*</b> | <b>\$98.00</b>     | <b>\$198.00</b> | Exclusive double comfort cushion featuring both memory and support foams  |
| <b>UPHCFT</b>           | <b>\$66.00</b>     | <b>N/A</b>      | Memory foam sub-layer (i.e., viscoelastic foam located underneath HR foam to preserve aesthetics while still enhancing sitting comfort). Call OM for compatibility. |
| <b>UPHMF</b>            | <b>\$66.00</b>     | <b>N/A</b>      | 5 lbs. memory foam layer applied to surface of seat cushion, underneath fabric  |
| <b>LUM</b>              | <b>\$71.00</b>     | <b>N/A</b>      | Adjustable lumbar option add-on (not available on all models, call OM for details)  |
| <b>UPHCA133</b>         | <b>\$80.00</b>     | <b>N/A</b>      | Upholstery with fire barrier to meet CA-TB 133 fire code (use for AF, BC4_, CL1_, CL3_, CLFT, CLVS, YS)   |
| <b>UPHTB133</b>         | <b>\$119.00</b>    | <b>N/A</b>      | Upholstery with fire barrier to meet CA-TB 133 fire code (use for models not mentioned above)   |
| <b>UPHDUB1</b>          | <b>\$40.00</b>     | <b>\$69.00</b>  | Upholstery back for small and BC Series task chairs (0.5 yard)  |
| <b>UPHDUB2</b>          | <b>\$50.00</b>     | <b>\$83.00</b>  | Upholstery back for large and BC Series executive chairs (0.75 yard)  |
| <b>UPHDUB3</b>          | <b>\$70.00</b>     | <b>\$102.09</b> | Upholstery back for complex backshells (1 yard)   |
| <b>UPHDUB-B</b>         | <b>\$55.00</b>     | <b>N/A</b>      | Ballistic Nylon upholstery on backshell   |
| <b>UPHDUB-T</b>         | <b>\$70.00</b>     | <b>\$102.09</b> | Upholstery back for chairs using Comfort Knit   |
| <b>UPHCYX</b>           | <b>\$98.00</b>     | <b>N/A</b>      | Concealed ultra-soft foam reservoir to relieve tailbone (coccyx) pressure (Grade 2 and 5 only)  |
| <b>UPH-PD</b>           | <b>\$88.00</b>     | <b>N/A</b>      | Durable Ballistic Nylon added to lower half, front portion of backrest. Check with factory.   |
| <b>COL</b>              | <b>\$120.00</b>    | <b>N/A</b>      | Customer's own leather (add upcharge to Grade 1 price)  |
| ESD STANDARD*           | List \$ (Upcharge) | List \$ (Buy)   | Description   |
| <b>ESDPKG</b>           | <b>\$193.00</b>    | <b>N/A</b>      | ESD Package – Fabric: Special assembly to meet ESD requirements   |
| <b>ESDPKG</b>           | <b>\$215.00</b>    | <b>N/A</b>      | ESD Package – Vinyl: Special assembly to meet ESD requirements  |
| <b>ER75PU</b>           | <b>N/A</b>         | <b>\$109.00</b> | ESD arm kit   |
| OPTIONS*                | List \$ (Upcharge) | List \$ (Buy)   | Description (Available on BC and WS Series only)  |
| <b>BSEWS15T</b>         | <b>\$42.00</b>     | <b>\$77.00</b>  | Unibody nylon reinforced black base (R-Base)  |
| <b>CEZABC</b>           | <b>\$10.00</b>     | <b>N/A</b>      | Semi-assembly for BC chairs packaged in carton  |
| <b>FTGBC41</b>          | <b>\$16.00</b>     | <b>\$59.00</b>  | 18" chrome footing for BC, CL and WS (or exchange with black plastic footing)   |
| <b>FTG20PL</b>          | <b>\$16.00</b>     | <b>\$59.00</b>  | 20" black plastic footing for BC and WS (or exchange with chrome footing)   |
| <b>TLTRAY</b>           | <b>N/A</b>         | <b>\$42.30</b>  | Tool tray fits WS Series workstools and other chairs (check with OM for compatibility)  |
| OPTIONS*                | List \$ (Upcharge) | List \$ (Buy)   | Description (Available on chairs that are not BC Series)  |
| <b>FTG20CR</b>          | <b>\$38.00</b>     | <b>\$78.00</b>  | 20" chrome adjustable footing   |
| <b>CRMPKG</b>           | <b>\$75.00</b>     | <b>\$123.00</b> | Chrome package: 5" chrome cylinder and polished aluminum base (base size depends on model selection)  |
| <b>GSPPKG**</b>         | <b>\$55.56</b>     | <b>\$166.67</b> | Spider base with chrome footing and dual-colored, 65mm soft casters 8" cylinder and flat fixed footing  |
| <b>TLPKG**</b>          | <b>\$55.56</b>     | <b>\$166.67</b> | Knobless, turn-lock footing stool package with 10" chrome cylinder and 26" nylon base carpet casters  |
| <b>HDPKG</b>            | <b>\$100.00</b>    | <b>N/A</b>      | 5" heavy-duty cylinder, heavy-duty engineered composite base and casters (HDPKG not available on all models. Check with factory.)                                   |
| <b>BSEYS78-PLH</b>      | <b>\$55.56</b>     | <b>\$166.67</b> | Polished aluminum base option available for most models (check with OM for compatibility)   |
| <b>COM-LOGO</b>         | <b>Call</b>        | <b>N/A</b>      | Call factory for pricing (\$55.56 list minimum per unit)  |
| <b>UPHCLN</b>           | <b>\$125.00</b>    | <b>N/A</b>      | Upholstery modifications for Cleanroom chairs (can only be used with vinyl or similar). Select models. Check with factory.  |
| <b>MCHPTRV</b>          | <b>\$30.00</b>     | <b>N/A</b>      | -RV Executive Synchronized mechanism features 5-lockout positions and independent back angle adjustment. Check with OM for compatibility.                           |
| <b>HRZA</b>             | <b>\$103.00</b>    | <b>N/A</b>      | Evita leather upholstered 3-way adjustable headrest (not retrofittable. Check with factory for model compatibility).  |

\* Limitations may apply. Not available for every model. Consult with an OM representative for compatible models.

\*\* GSPPKG & TLPKG only eligible as upcharge to stool configurations. When altering a chair to a stool configuration, check with OM for eligibility and use "Buy" column pricing.

Be advised that all the options listed above may not be applicable to all models in our price list. Pricing and specifications subject to change without notification.

1110 South Mildred Avenue Ontario, California 91761  
toll free 877 776 5678 voice 909 392 5678 facsimile 909 392 4567

[omsmartseating.com](http://omsmartseating.com)  
September 2015

